



WhisperPowerBook

Product Catalogue #1

Mobile

Marine

Offgrid

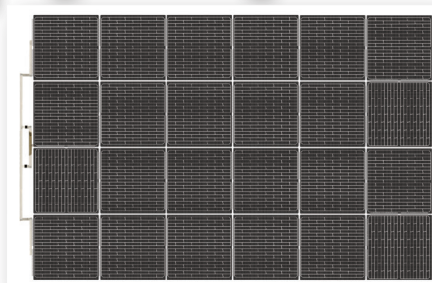
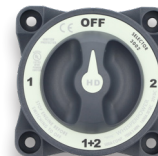
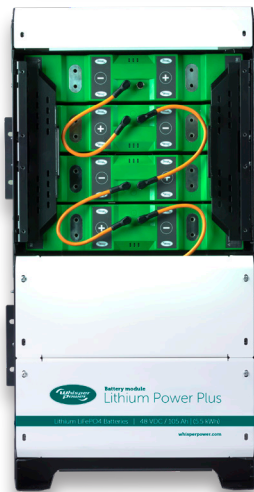

Enjoy Green Energy

whisperpower.com



Zero-emission power for work trucks



Auxiliary power for e-mobility



Commercial shipping



System solutions for motorhomes



Offgrid power facilities















Recreational marine

The information contained in this catalogue is for general information purposes only. While we endeavour to keep the information up to date and correct, we cannot be held responsible for alterations of specifications of products over time.



Comfort systems for RV's



Convert		Battery Chargers	12 / 24 / 48 VDC	4	Chargers
		DC-DC Converters	12 / 24 / 48 VDC	22	Converters
		Sine Wave Inverters	12 / 24 VDC	28	Inverters
		Sine Wave Inverter / Charger Combinations	12 / 24 / 48 VDC	29	Combi's
		All-In-One OctoPower	3 kW / 12 VDC	46	OctoPower
Generate		Solar	<ul style="list-style-type: none"> • Solar Panels • Solar Charge Controllers • Solar Installation Parts 	48	Solar
		Alternators	12 / 24 VDC 230 VAC	49	Alternators
Store		Batteries	Lithium / AGM / GEL	62	Batteries
Connect		AC Distribution	<ul style="list-style-type: none"> • Isolation Transformers • Galvanic Isolators • Transfer Switches • Land Power Connections 	82	Connect AC
		DC Distribution	<ul style="list-style-type: none"> • Battery Isolators • Battery Switches • Fuses & Fuse holders 	98	Connect DC
Control		Monitoring & Control	<ul style="list-style-type: none"> • Battery Monitoring • System Control Panels • WhisperCare 	122	Control
Company		The Company	<ul style="list-style-type: none"> • Company Profile • Service & Support • Available Documentation 	142	Company



WhisperPower

Premium Power Conversion

High standard power electronics is the key to creating a quiet, intelligent, energy-efficient and environmentally friendly energy system that lasts forever. The vast majority of these products has been developed in recent years by WhisperPower with the main goal of a perfect integration of the power electronics with the power storage, and eventually the power generation systems.

The reliability of an electrical system is determined by the quality of its components. Weak links are disastrous for this reliability. That is why WhisperPower supplies components, including automatic battery chargers, of the highest quality. We offer a wide range, from small chargers for maintenance charging of starter- or back-up batteries, up to fast chargers for heavy duty (professional) applications.

What all WhisperPower Battery Chargers have in common

- Ultra compact due to switch mode technology applied
- Minimal audible noise, no buzzing
- Multi – step charge curve, suitable for any battery
- Global AC input (90 - 265 VAC, 50 - 60 Hz) *)
- Perfect solutions to charge Lithium batteries *)
- Most chargers have multiple outputs for 2 to 3 separate batteries *)

*) Not valid for the Handy series

Battery Charger / Rectifier Series

Heavy Duty Supreme Pro

40 - 100 A, 24 VDC

[Go to Page 6](#)



Heavy Duty System Charger

DC PowerCube Series

24 VDC - 150 A | 48 VDC - 80 A

[Go to Page 12](#)



Cost Effective Multi-Purpose Battery Chargers

Supreme Series

20 - 100 A, 12 VDC

Go to Page 16



Light Duty Battery Chargers

Handy Series

2 - 15 A, 12 VDC

Go to Page 20



Multifunctional

DC-DC converters

Go to Page 22



Inverters & Inverter/Charger Combinations

WP-Sine | WPC

Supreme Combi

Go to Page 28



Pre-assembled Systems

OctoPower 3

Go to Page 46

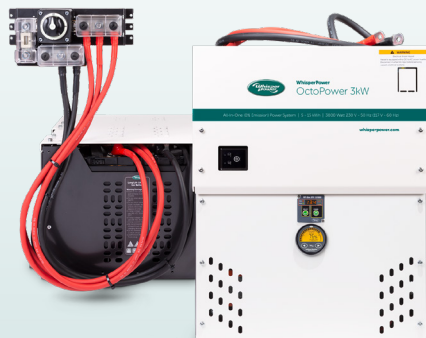



Battery charger/rectifier series

Supreme Pro

Commercial vessels, yachts, vehicles and industrial installations carry an enormous amount of electrical and electronic devices that require a safe and non-stop power provision. WhisperPower's Supreme professional battery chargers combine three vital functions. Smooth, ripple free multiple step battery charging, a power supply function to buffer DC appliances in a direct way and a complete alarm and monitoring device for the entire 24 VDC system. All models are prepared to operate from 90 - 265 VAC / 50 - 60 Hz input and are fitted with three separate outputs.

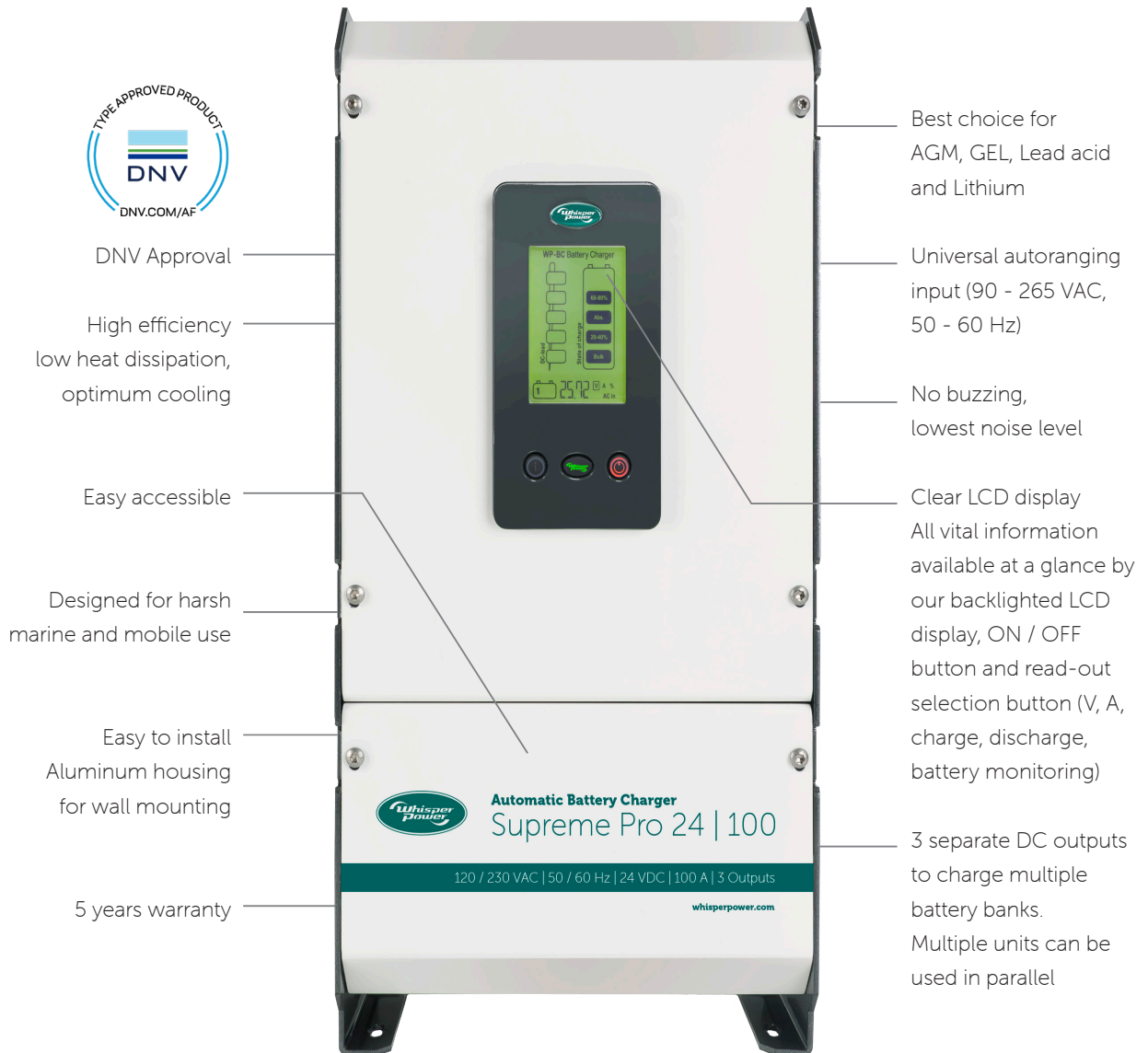

Perfect all-in-one solution

- Powerful battery charger, suitable for any type of battery
- Ripple free rectifier to operate DC appliances in a direct way
- 3 separate outputs to charge multiple battery banks
- Universal single phase input (90 - 265 VAC, 50 - 60 Hz, full power)
- Proven switched mode technology, cool operation, IUoUo charging
- Parallel use for high power central (DC-UPS) power systems possible

Standard features

- Compact, light weight, Aluminum enclosure for bulk head or table top mounting
- Full functional LCD front display with backlight, ON-OFF switch, read-out selector button
- Battery monitor operational, at "ON" or "OFF" position
- Charge protocol selection by dipswitch, USB and laptop, including Lithium
- Temperature sensor with 12 metre cable and plug
- Robust AC and DC M8 bold connections to connect 3 separate batteries
- Conformal coating protection of power module inside
- Perfectly suitable to back up GMDSS systems
- 5 years product warranty



Optional

- WhisperTouch 5, 7 or 10 remote panel
- Analogue remote panels showing "charge status" and "current" control
- AGM, GEL, Lead acid or Lithium batteries

Alarms and monitoring

- Potential free contacts to detect "AC failure" and "charger failure" alarms, "DC voltage high/low alarm" and "charger temperature" alarm
- WhisperConnect CAN-bus connection possible to connect to other can systems, incl. NMEA 2000
- Analogue interfaces, + and - sense
- USB interface for charge characteristic programming
- Remote panel with current adjust, to reduce AC consumption





Wide voltage input

Universal AC input, from 90 – 265 VAC, 50 - 60 Hz, over the whole range full DC output.



Control at a glance

Compact, easy to connect remote panels, WhisperTouch or LED based analogue panels, with remote adjustment feature to adjust the charge current according to the AC power availability. Compatible with remote panels of other chargers 1.2. Mass-series.

GMDSS

GMDSS - Ready

The right choice for back-up power systems, connected to Global Marine Distress and Safety systems, all relevant alarms are fitted as standard.



The right approval

We offer the entire range with DNV and UL class approval as standard.



All models are suitable for parallel operations.

Wide choice, one size fits all

Supreme Pro 24 | 40, 24 | 60, 24 | 80 and 24 | 100. Robust design suitable for extreme harsh circumstances. Operating temperature -25 up to 60°C.



Professional connections

Internal AC and DC connections (hard wiring) with maximum distance in between, Plug and Play single cable connectivity for the following functions:

- Remote panels
- Temperature sensor, to be put on the battery
- WhisperConnect, 2 ports for easy connection to system
- USB interface for specific uploading

THE ULTIMATE WAY OF CHARGING

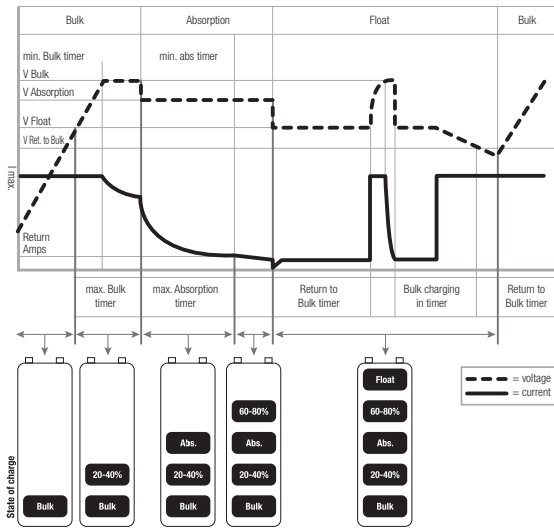

Clear indications at the Liquid Crystal Display (LCD) showing DC charge current, DC load (even when the charger is switched OFF), DC voltage and various AC / DC failure alarms. The graphs above are showing the charge characteristics of the Supreme Pro charger in case Lead acid batteries are connected. For Lithium batteries a constant voltage mode can be selected by dip switch setting.

FRONT PANEL INDICATORS

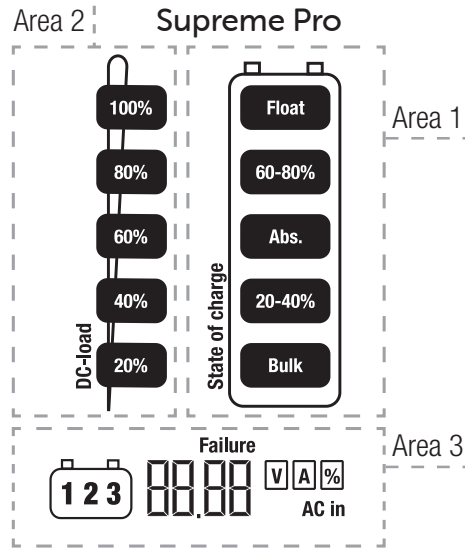

LCD display indicates voltage (DC) and Amps in figures, Amps also in graphics. Information button to select battery 1, 2 or 3. Display is in conformity with GMDSS requirements and is showing the necessary values.

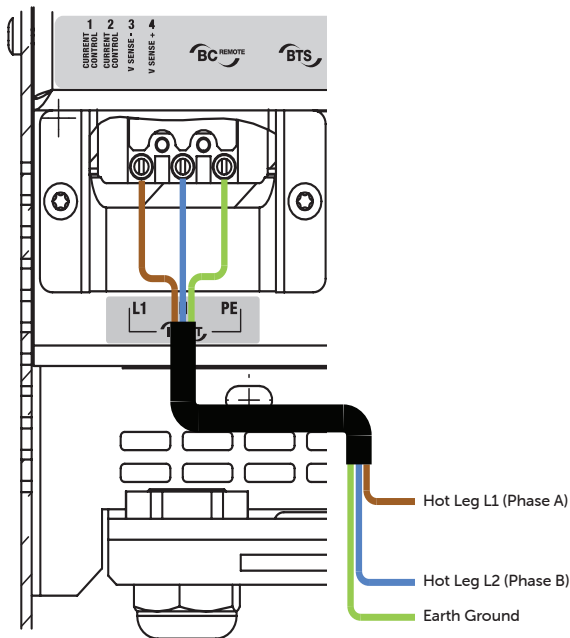

AC connection compartment, hard wiring for AC connection cables. Universal input 110 / 120 / 230 VAC, 50 - 60 Hz.

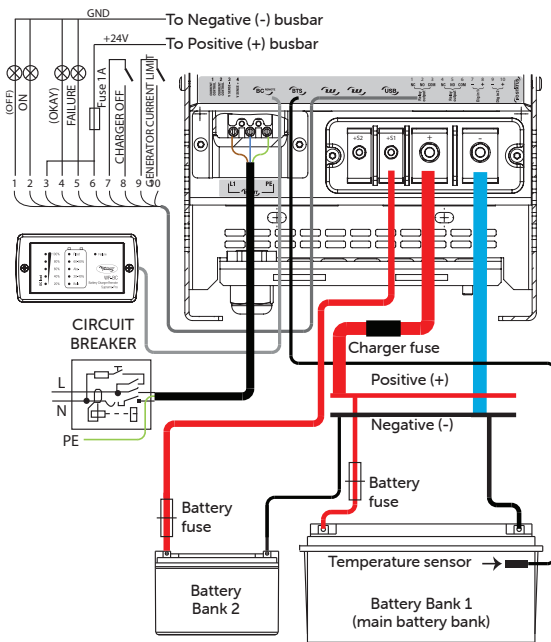

Easy accessible connection compartment, with proper glands for the incoming cables. Robust, heavy duty studs for the battery / DC connections, kept separate from the printed circuit board.



All features and benefits a professional battery charger should have



Supreme Pro Series

	24 VDC 40 A	24 VDC 60 A	24 VDC 80 A	24 VDC 100 A
Article Number	60205440	60205460	60205480	60205401
GENERAL SPECIFICATIONS				
Nominal input voltage	120 / 230 VAC (90 - 265 VAC)	120 / 230 VAC (90 - 265 VAC)	120 / 230 VAC (90 - 265 VAC)	120 / 230 VAC (90 - 265 VAC)
Nominal input frequency	50 / 60 Hz (45 / 65 Hz)	50 / 60 Hz (45 / 65 Hz)	50 / 60 Hz (45 / 65 Hz)	50 / 60 Hz (45 / 65 Hz)
Nominal output voltage	24 VDC	24 VDC	24 VDC	24 VDC
Total charge current	40 A at 28.8 VDC	60 A at 28.8 VDC	80 A at 28.8 VDC	100 A at 28.8 VDC
Number of battery outlets	3	3	3	3
Charge current second output	6 A, ± 1 A	6 A, ± 1 A	6 A, ± 1 A	6 A, ± 1 A
Charge current third output	6 A, ± 1 A	6 A, ± 1 A	6 A, ± 1 A	6 A, ± 1 A
Charge characteristic	IUoUo, automatic / 3-step for GEL / AGM / Lead acid batteries			
Charge voltage Bulk (25°C) *)	28.8 VDC	28.8 VDC	28.8 VDC	28.8 VDC
Charge voltage Absorption (25°C) *)	28.5 VDC	28.5 VDC	28.5 VDC	28.5 VDC
Charge voltage Float (25°C) *)	26.5 VDC	26.5 VDC	26.5 VDC	26.5 VDC
Max. Absorption time *)	4 hours	4 hours	4 hours	4 hours
Max. Bulk time (start at 13.25 / 26.5 VDC) *)	8 hours	8 hours	8 hours	8 hours
Min. Absorption time *)	15 minutes	15 minutes	15 minutes	15 minutes
Dimensions (W x D x H) in mm	210 x 145 x 445	210 x 145 x 445	210 x 145 x 445	210 x 145 x 445
Dimensions (W x D x H) in inch	8.2 x 5.7 x 17.5	8.2 x 5.7 x 17.5	8.2 x 5.7 x 17.5	8.2 x 5.7 x 17.5
Weight	6.3 kg / 13.89 lb	6.3 kg / 13.89 lb	6.6 kg / 14.55 lb	6.6 kg / 14.55 lb
Battery capacity (recommendation)	100 - 500 Ah	150 - 750 Ah	300 - 800 Ah	400 - 1500 Ah
TECHNICAL SPECIFICATIONS				
Power factor (cos phi)	≥ 0.97	≥ 0.97	≥ 0.97	≥ 0.97
Full load consumption (230 VAC)	1400 VA	2000 VA	2700 VA	3375 VA
Temperature compensation	by BTS-Battery temperature sensor, standard supply			
Voltage compensation	yes, automatic	yes, automatic	yes, automatic	yes, automatic
DC consumption with connected battery	< 5 mA	< 5 mA	< 5 mA	< 5 mA
Display	LCD	LCD	LCD	LCD
Temperature range	-25 up to 60°C / -13 up to 140°F, above 40°C derating			
Cooling	Vario fan and natural cooling to ensure optimized cooling			
Sound level	< 55 dBA at 1 m	< 55 dBA at 1 m	< 55 dBA at 1 m	< 55 dBA at 1 m
Protection degree	IP23	IP23	IP23	IP23
Optional	Remote panel WP-SCC for remote power adjustment (electronic or turning knob) WhisperTouch 7 or 10 inch			

*) Adjustable by dip switch, USB or WhisperConnect



Supreme Pro | Basic Remote
Standard Supply



Supreme Pro | Current Adjust
Push button
Art. Nr. 60205060



WhisperTouch
Art. Nr. 40280101 - 7 inch
Art. Nr. 40280102 - 10 inch



Temp sensor
6 meter cable
Art. Nr. 60201202



Supreme Pro | Current Adjust
Turning Knob
Art. Nr. 60205061

Supreme Pro Dimensions

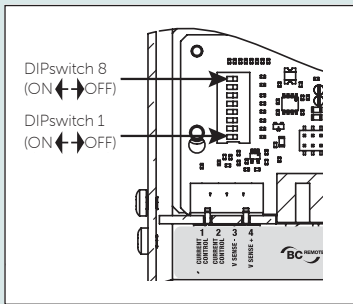
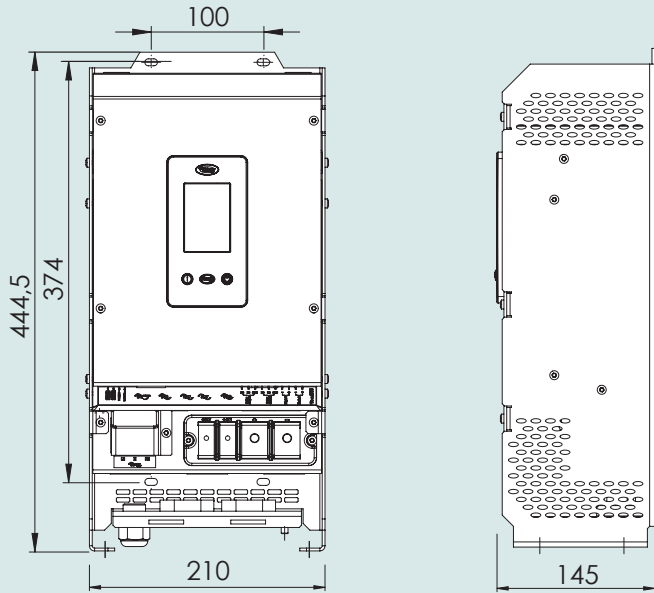

Easy accessible selector dip switches for various settings

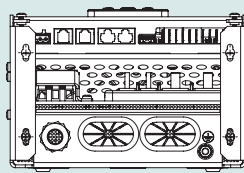

Approvals



DNV: Certificate Number: TAE00004EV



UL1236 Battery Chargers for Charging Engine-Starter Batteries
cUL: CSA C22.2 No. 107.2 Battery Chargers



E mark: Complies with the relevant EU/ECE regulations



CE: Good's conformity with European health, safety, and environmental protection standards

Suitable to charge any battery



No limitations

Any battery, either AGM, GEL, Lead acid, traction, or Lithium can be connected to the Supreme Pro. Easy programming by dip switch, USB connect or laptop. Three separate batteries can be connected (1 main, 2 x 6 Amp, all multiple step).





Heavy-Duty Battery Chargers

DC PowerCube

(24 VDC | 150 A / 48 VDC | 80 A)

The DC PowerCube battery charger / power supply is designed for more extensive electrical systems with a large battery bank and significant DC consumption. The DC PowerCube converts the delivered power (from the grid or generator) to DC for lighting, electronic equipment, pumps and other DC loads.

The DC PowerCube can deliver up to 4.3 kW (24 VDC or 48 VDC), enough to charge batteries quickly whilst still providing the various DC and AC loads with power for all equipment on board of even the biggest yachts and ships. The DC PowerCube can even be used as a power supply, without batteries, as the smooth output voltage is incredibly uniform and ripple free.

Heavy duty battery charger/ power supply at system level

Features

- DC power up to 150 A (48 VDC - 80 A)
- AC can be adjusted from 4 A to 16 A
- Provides up to 3.5 kW (24 or 48 VDC) from land power
- Up to 4.3 kW from Genverter®
- Adjustable Genverter® load (as well as rpm)
- Second 24 VDC output (three-step), 5 A
- 12 VDC / 20 A output, three-step, for 12 VDC batteries
- Standard analogue panel supplied
- WhisperConnect CAN-bus connection for central monitoring
- Suitable for worldwide use, 90 to 264 VAC, 50 / 60 Hz (automatically adjusts)

Benefits

- High powered charger / power supply for entire DC-system
- Ultra-short charging time and therefore saves fuel
- Battery type adjustable from laptop or dipswitch settings: AGM, GEL, Lead acid, Traction and Lithium
- Smooth, ripple-free DC output no "flickering" lights
- Various outputs: 24 VDC main output, 24 VDC slave, 12 VDC for one or more batteries
- Can be connected to any mains voltage or capacity
- Dual input: AC supply supplemented with uniform Genverter® input.



Marine / Mobile / Offgrid System Example

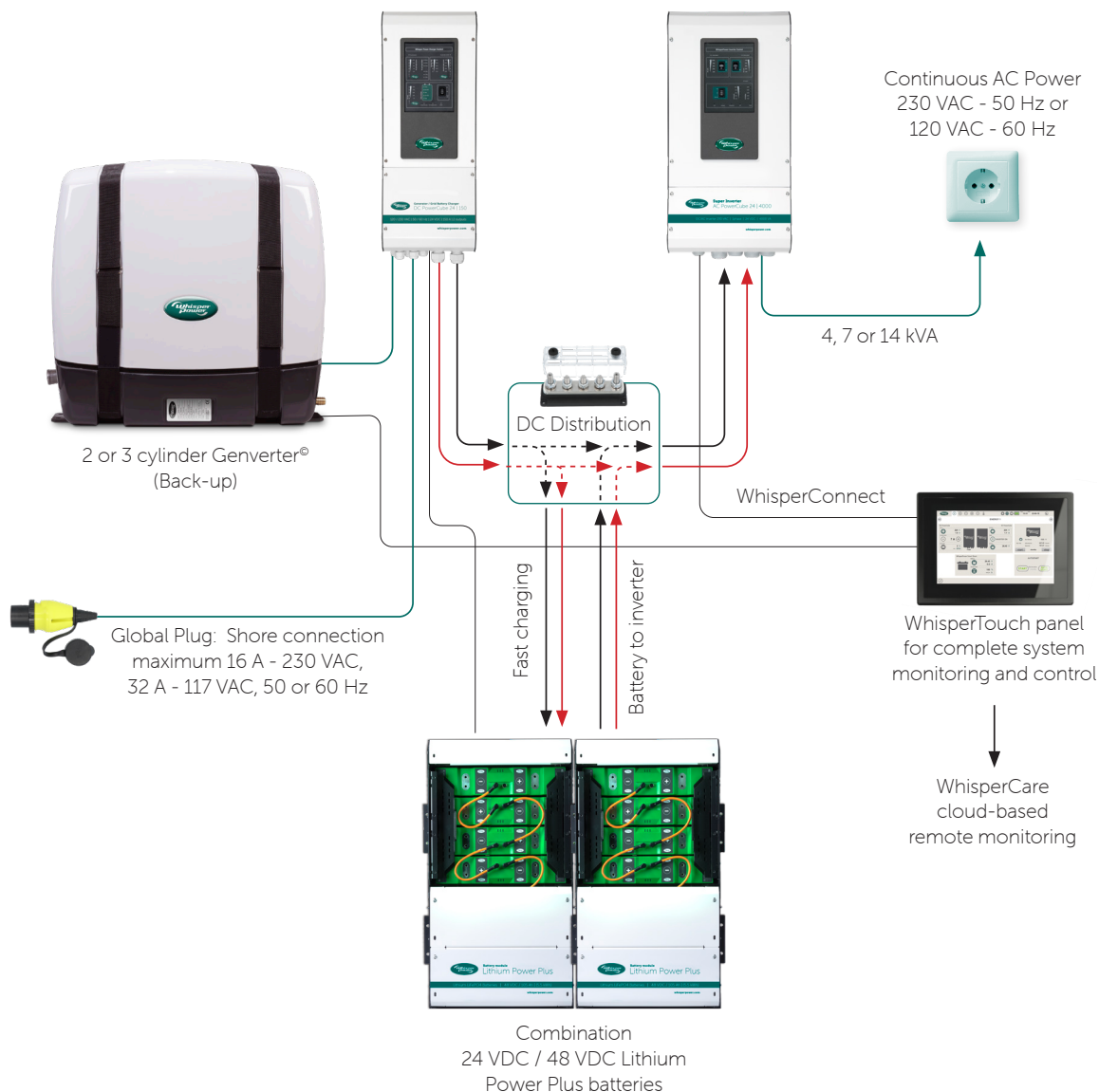

Dual functionality

The WhisperPower inverters and chargers are perfect system components, allowing a Plug and Play extension by connecting one of the Genverter® generator models, prepared to operate with one or more DC PowerCube super chargers. An ideal solution to charge Lithium battery systems fast and safely, with a minimum of generator running time.

For more information go to www.whisperpower.com and consult our various WhisperPowerBooks. Do not forget to watch our WhisperTV channel at YouTube.



Installation Drawings

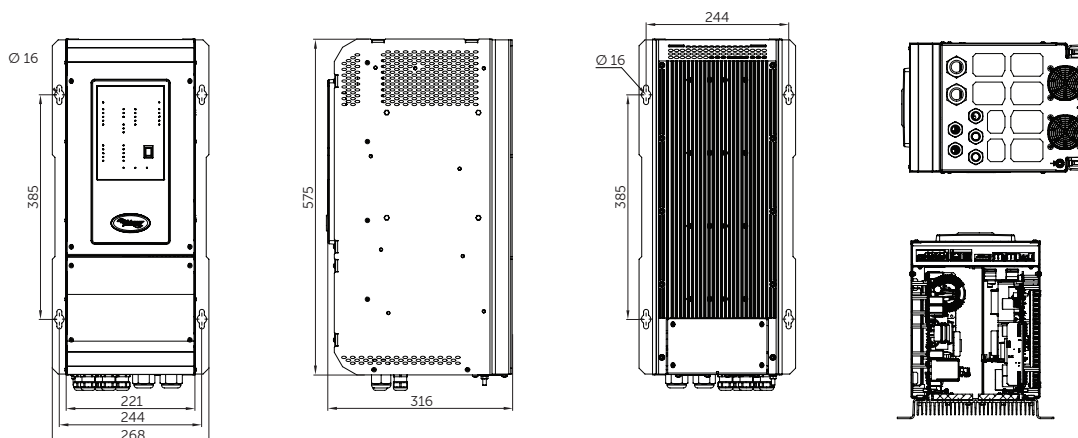



DC PowerCube Series



	24 VDC 150 A	48 VDC 80 A				
Article Number	60202002	60202003				
GENERAL SPECIFICATIONS						
Nominal battery voltage	24 VDC	48 VDC				
Charge current	0 - 150 A (protected against short circuit)	0 - 80 A (protected against short circuit)				
Output voltage	26.5 - 28.5 VDC	43 - 57 VDC				
Recommended battery capacity	300 to 1500 Ah	200 to 1000 Ah				
Charge characteristic	Three step charging characteristic, configurable, one step in case of Lithium					
Secondary charge output	12 VDC / 20 A or optional 24 VDC / 5 A (three steps) protected against short circuit					
INPUT SPECIFICATIONS						
AC voltage	90 - 264 VAC (45 - 65 Hz), earthed	90 - 264 VAC (45 - 65 Hz), earthed				
Input current	Adjustable from 2 A to 16 A	Adjustable from 2 A to 16 A				
Power factor (cos φ)	> 0.9	> 0.9				
Genverter® voltage	80 - 300 VAC (30 - 500 Hz), (3 wire connection)	80 - 300 VAC (30 - 500 Hz), (3 wire connection)				
Input current from Genverter®	Adjustable from 2 A to 14.5 A	Adjustable from 2 A to 14.5 A				
Power factor (cos φ) Genverter®	> 0.85	> 0.85				
Power factor correction	In accordance with EN 61000-3 - 2	In accordance with EN 61000-3 - 2				
TECHNICAL SPECIFICATIONS						
Temperature compensation	-30 mV / °C	-60 mV / °C				
Battery type	AGM, GEL, Lead acid, Traction and Lithium					
Leakage current	< 5 mA per battery bank					
Charge voltage	Bulk	Absorption	Float	Bulk	Absorption	Float
Charge voltage AGM / GEL at 25°C	28.8 VDC	28.5 VDC	27.2 VDC	57.6 VDC	57.0 VDC	54.4 VDC
Charge voltage traction battery at 25°C	29.2 VDC	28.9 VDC	26.5 VDC	58.4 VDC	57.8 VDC	53.0 VDC
Charge voltage Lead acid at 25°C	28.5 VDC	28.5 VDC	26.5 VDC	57.0 VDC	57.0 VDC	53.0 VDC
Charge voltage Lithium at 25°C	28.8 VDC	28.6 VDC	28.0 VDC	57.6 VDC	57.2 VDC	56.0 VDC
Switch point absorption-float	at 6 percent of I _{max}					
Charge status PowerCube ON-OFF	Digital output (relay, two-way contact)					
Failure condition present	Digital output (relay, two-way contact)					
DC PowerCube disabled	Digital input (potential free, disabled if closed)					
Genverter® input disabled	Digital input (potential free, disabled if closed)					
Conforms to	EMC Directive 2004/108 / EC: EN 61000-6-1, EN 61000-6-3, EN 55014, EN 55022, EN 61000-3-2, EN 62040-2 Low Voltage Directive					
PROTECTIONS						
Protection against overheating	Yes, derating above 40°C, shuts down at high temperatures (automatic restart once cooled down)					
Over voltage protection (manual restart needed)	36 ± 0.5 VDC			68 ± 0.5 VDC		
International Protection rating	IP21			IP21		
MECHANICAL SPECIFICATIONS						
Main battery connection	2x threaded M10 screws			2x threaded M10 screws		
Secondary battery connection	1x threaded M5 screws			1x threaded M5 screws		
Earth clamp	1x threaded M6 screws			1x threaded M6 screws		
AC input	M3 triple terminal block			M3 triple terminal block		
Genverter® input	M3 triple terminal block			M3 triple terminal block		
Remote control panel	RJ12			RJ12		
Battery temperature sensor	RJ12			RJ12		
WhisperConnect CAN-bus	RJ45			RJ45		
Voltage measurement	Phoenix MSTB 2.5 / 2-ST-5.08			Phoenix MSTB 2.5 / 2-ST-5.08		
Digital outputs	6x faston (6.3 x 0.8)			6x faston (6.3 x 0.8)		
Digital inputs	4x faston (6.3 x 0.8)			4x faston (6.3 x 0.8)		
Dimensions (W x D x H) in mm	221 x 316 x 575			221 x 316 x 575		
Relative humidity during operation	to 95 %, non-condensing			to 95 %, non-condensing		
Cooling	Combined (convection and variable mechanical)					
Weight	26 kg			26 kg		
Noise level	< 52 dB			< 52 dB		
Warranty	5 years			5 years		
Accessories (standard supply)	Battery temperature sensor and remote control panel					

DC PowerCube Battery Chargers Functions & Connections

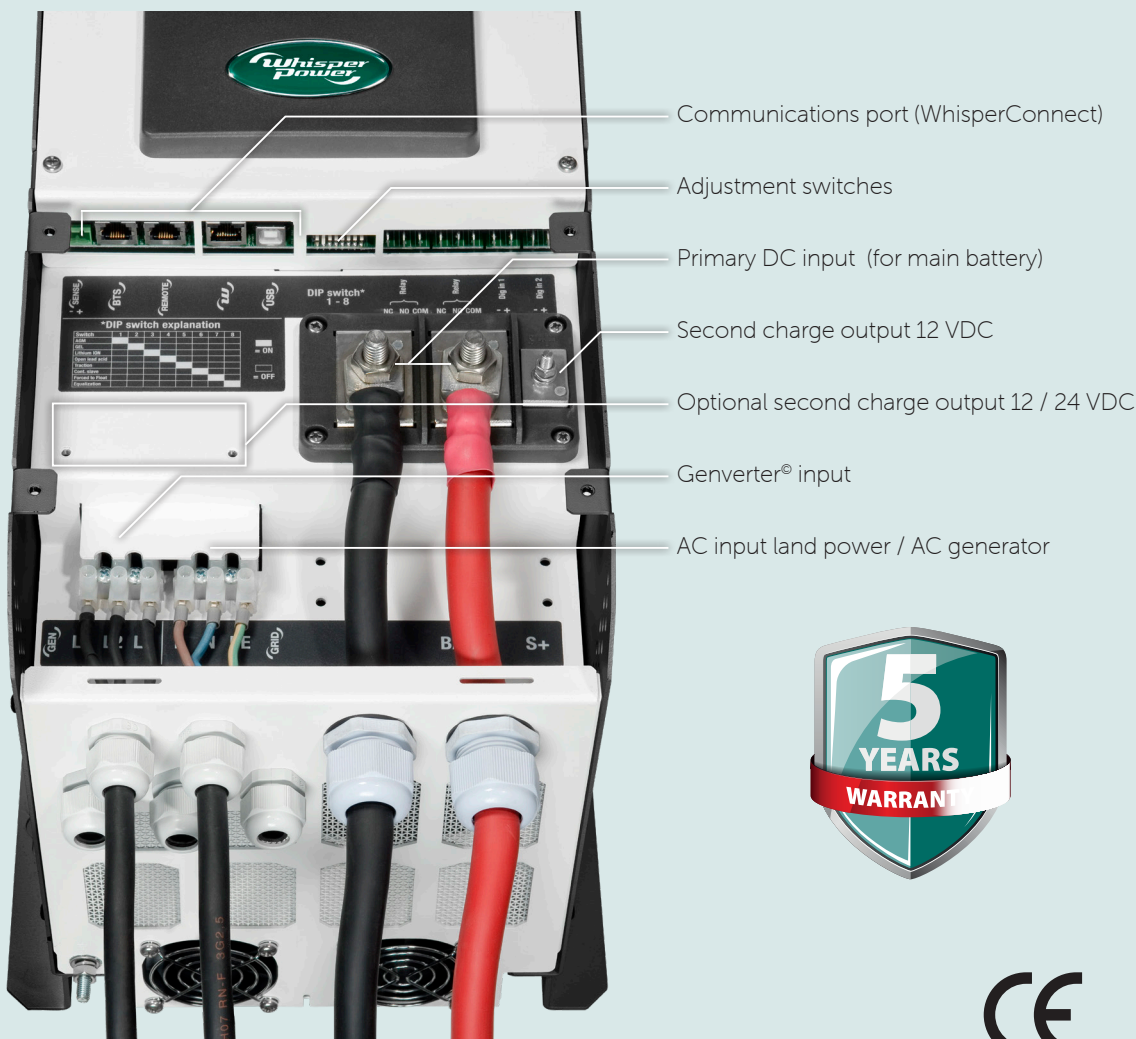

The DC PowerCube uses a multi-step charging algorithm (IUoUo) whereby the batteries are charged quickly and safely and their lifespan is extended. The different stages of the charging process can be viewed on the DC PowerCube's charge bar and on the remote control panel. If the DC PowerCube is charging, the bulk-LED is always on. The indicator for 20 - 40 % illuminates if the charging voltage is higher. If the charging voltage is increased to the bulk value of 28.5 / 57 VDC (depending on the type of battery), the charger switches to the absorption phase. The charging current decreases, and when it has fallen to less than 6 % of the maximum charging current, the indicator for 60 - 80 % illuminates. 15 minutes later, the charger moves to the float phase. If the battery voltage drops to 25.6 / 51.2 VDC, the charger switches once again from float to bulk mode.

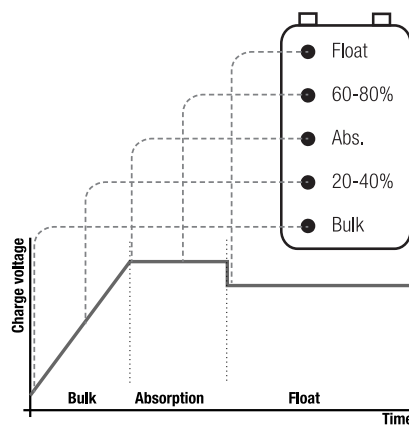

DC PowerCube Remote
Art. Nr. 60202050



Automatic battery chargers with multiple output Supreme Series

WhisperPower's Supreme series battery chargers are designed for fixed installation in vehicles, yachts and other vessels. These powerful battery chargers which can charge three independent batteries. The Automatic Battery Charger Supreme is easy to programme for AGM , GEL, Lead-acid and Lithium batteries. The charger can handle input voltages from 90 to 265 VAC (50 / 60 Hz) and can therefore be used worldwide.



Features

- Designed to charge three independent batteries
- Also suitable for one or two batteries
- Batteries can differ in capacity (Ah)
- Programmable for AGM, GEL, Lead acid and Lithium batteries
- Temperature sensor standard
- Temperature sensor protects against risk of gas production
- Automatically adjusts supply voltage for world-wide use (90-265 VAC)
- Works with small gasoline or diesel generators
- Complies with CE and ABYC standards

Benefits

- Fast charge even with low input voltage
- Each output can be programmed differently
- Battery connection easily accessible, AC power cord supplied
- Quick install
- Quiet - no hum from transformer
- Maximizes battery life time
- Outstanding price - performance ratio



Supplied as standard with temperature sensor

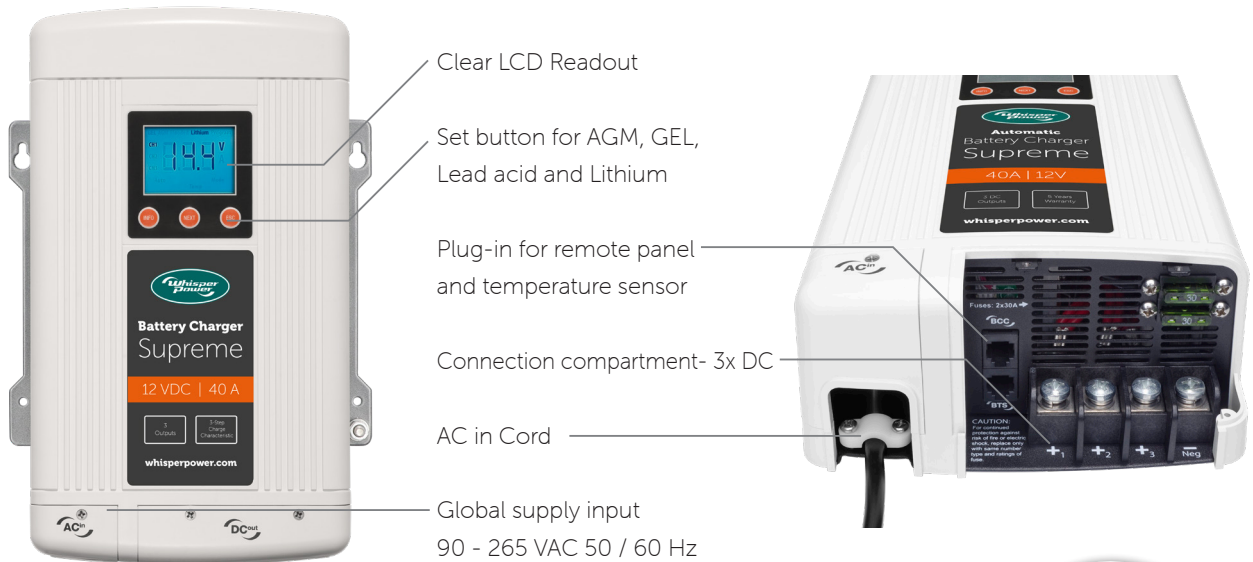

Ultra Compact & Powerful



Individual set up of each output

Example of use

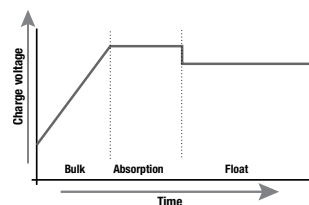
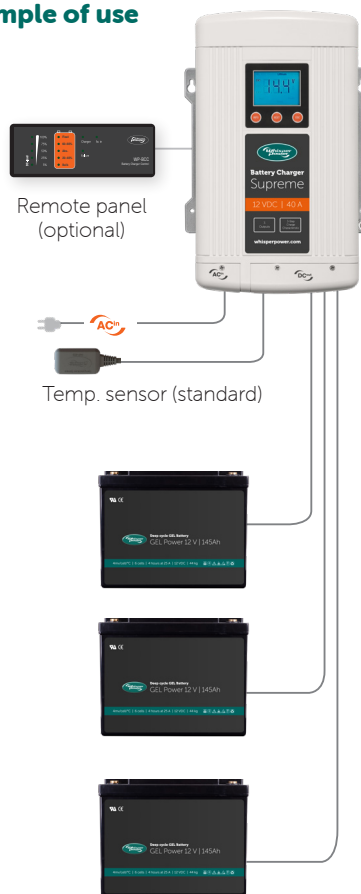

3-step charge curve with the Supreme

For charging 48 VDC Batteries
Go to Page 38



Supreme Remote
Incl. 6 m cable | optional
Art. Nr. 61112301





Supreme Series

	12 VDC 20 A	12 VDC 40 A
Article Number	61112302	61112304
CHARGER OUTPUT		
Output current (maximum)	20 A	40 A
Output voltage charge	14.2 - 15.5 VDC	14.2 - 15.5 VDC
Output voltage float	13.4 - 13.8 VDC	13.4 - 13.8 VDC
Output voltage equalize	16 VDC	16 VDC
Charging control	3-step (bulk/absorption/float)	3-step (bulk/absorption/float)
DC output bank	3	3
Selectable battery type	AGM, GEL, Lead acid, Lithium	AGM, GEL, Lead acid, Lithium
Leakage current	< 2 mA	< 2 mA
CHARGER INPUT		
Input voltage (nominal)	100, 120, 220, 230, 240 VAC	100, 120, 220, 230, 240 VAC
Input variation	90 - 265 VAC	90 - 265 VAC
Input frequency range	47 - 63 Hz	47 - 63 Hz
Power consumption (full load)	350 W	700 W
Power factor correction	Yes	Yes
Charge efficiency	> 82 %	> 82 %
DISPLAY		
LCD display (with back lighting)	Charging status, battery voltage	Charging status, battery voltage
Warning and fault code	A01-02, E01-09	A01-02, E01-09
PROTECTION AND FEATURES		
Reverse battery / over charge	Yes, device shuts down	Yes, device shuts down
Overheating	Yes, device de-rates and shuts down	Yes, device de-rates and shuts down
Output short circuit	Yes, device shuts down	Yes, device shuts down
DC fuse	2*15 A / 32 VDC	2*30 A / 32 VDC
Cooling	Mechanical	Mechanical
Battery temperature sensor port	RJ12 (battery temp. sensor use)	RJ12 (battery temp. sensor use)
Digital display port	RJ12 (optional remote display panel)	RJ12 (optional remote display panel)
AC AND BATTERY CONNECTIONS		
AC input connection	Hardwired or AC Cord	Hardwired or AC Cord
DC output connection	Heavy duty threaded screws (for 3 batteries)	Heavy duty threaded screws (for 3 batteries)
DC output (min.)	Shared, heavy duty threaded screws	Shared, heavy duty threaded screws
ENVIRONMENTAL AND OPERATING TEMPERATURE		
Storage temperature	-40 up to 70°C	-40 up to 70°C
Operating temperature	-20 up to 60°C	-20 up to 60°C
Relative humidity	5 - 95 %, RH non-condensing	5 - 95 %, RH non-condensing
International Protection rating	IP32	IP32
WEIGHT AND DIMENSIONS		
Weight	2.4 kg / 5.3 lb	2.6 kg / 5.7 lb
Dimensions (W x D x H) in mm	206 x 86 x 295	206 x 86 x 295
Dimensions (W x D x H) in inches	8.1 x 3.4 x 11.6	8.1 x 3.4 x 11.6
CONFORMITY		
Standards/safety (North-America)	Conforms to UL1236 with marine appendix UL1564 CSA C22.2 107.2-01	
Standards/safety (European Union)	CE Marking for Low Voltage Directive 2006-95-EC Conforms to EN60335-2-29 (battery chargers) Conforms to IEC60529: 2001, protection class IP32	
Standards/safety (North-America)	Class B FCC Part 15B and ANSI C63.4	
Standards/safety (European Union)	CE Marking for EMC Directive 2004-108-EC Meets EN55014-1, EN55014-2, EN61000-3-2 and EN61000-3-3 (in accordance with IEC standards)	

**12 VDC | 60 A****12 VDC | 100 A****24 VDC | 30 A**

61112306

61112310

61124303

60 A

100 A

30 A

14.2 - 15.5 VDC

14.2 - 15.5 VDC

28.4 - 31 VDC

13.4 - 13.8 VDC

13.4 - 13.8 VDC

26.8 - 27.6 VDC

16 VDC

16 VDC

32 VDC

3-step (bulk/absorption/float)

3-step (bulk/absorption/float)

3-step (bulk/absorption/float)

3

3

3

AGM, GEL, Lead acid, Lithium

AGM, GEL, Lead acid, Lithium

AGM, GEL, Lead acid, Lithium

< 2 mA

< 2 mA

< 2 mA

100, 120, 220, 230, 240 VAC

100, 120, 220, 230, 240 VAC

100, 120, 220, 230, 240 VAC

90 - 265 VAC

90 - 265 VAC

90 - 265 VAC

47 - 63 Hz

47 - 63 Hz

47 - 63 Hz

1050 W

1800 W

1050 W

Yes

Yes

Yes

> 82 %

> 84 %

> 82 %

Charging status, battery voltage

Charging status, battery voltage

Charging status, battery voltage

A01-02, E01-09

A01-02, E01-09

A01-02, E01-09

Yes, device shuts down

Yes, device shuts down

Yes, device shuts down

Yes, device de-rates and shuts down

Yes, device de-rates and shuts down

Yes, device de-rates and shuts down

Yes, device shuts down

Yes, device shuts down

Yes, device shuts down

3*30 A / 32 VDC

3*30 A / 32 VDC

3*30 A / 32 VDC

Mechanical

Mechanical

Mechanical

RJ12 (battery temp. sensor use)

RJ12 (battery temp. sensor use)

RJ12 (battery temp. sensor use)

RJ12 (optional remote display panel)

RJ12 (optional remote display panel)

RJ12 (optional remote display panel)

Hardwired or AC Cord

Hardwired or AC Cord

Hardwired or AC Cord

Heavy duty threaded screws (for 3 batteries)

Heavy duty threaded screws (for 3 batteries)

Heavy duty threaded screws (for 3 batteries)

Shared, heavy duty threaded screws

Shared, heavy duty threaded screws

Shared, heavy duty threaded screws

-40 up to 70°C

-40 up to 70°C

-40 up to 70°C

-20 up to 60°C

-20 up to 60°C

-20 up to 60°C

5 - 95 %, RH non-condensing

5 - 95 %, RH non-condensing

5 - 95 %, RH non-condensing

IP32

IP32

IP32

4 kg / 8.8 lb

6.4 kg / 14.1 lb

4 kg / 8.8 lb

206 x 99 x 356

236 x 103 x 425

206 x 99 x 356

8.1 x 3.8 x 14

9.3 x 4.1 x 16.7

8.1 x 3.8 x 14

Conforms to UL1236 with marine appendix UL1564 CSA C22.2 107.2-01

CE Marking for Low Voltage Directive 2006-95-EC Conforms to EN60335-2-29 (battery chargers)
Conforms to IEC60529: 2001, protection class IP32

Class B FCC Part 15B and ANSI C63.4

CE Marking for EMC Directive 2004-108-EC Meets EN55014-1, EN55014-2, EN61000-3-2
and EN61000-3-3 (in accordance with IEC standards)



Automatic battery chargers for small systems

Handy Series

Our Handy battery chargers are ideal for charging all kinds of small batteries. Whether it is for AGM, GEL or larger Lead acid starter batteries in extensive electrical systems, the fully automatic Handy quickly and completely charges the battery, benefiting both the lifespan and reliability of the battery. The Handy chargers, which include a bracket for fixed mounting, are supplied with everything needed to connect the charger to the AC source and battery. There are three versions available. For 12 VDC batteries: 7 A, 15 A and 24 VDC / 6 A.



AGM	✓
GEL	✓
Lead acid	✓



Features

- Advanced five-step charging process
- Fully automatic, suitable for AGM, GEL and Lead acid batteries
- Set-up menu for each type of battery
- Temperature sensor for safe charging fitted as standard
- Clear charge status indicator
- Built-in flash light (torch) in 7 A and 15 A versions
- Plug and Play, ready to use



Benefits

- Fast and complete battery charge
- Handy charger can remain connected to the battery
- Significantly increases battery life span
- Safe polypropylene housing, suitable as separate and fixed charger (IP54)
- Water resistant, suitable for outdoor use
- Compact and easy to install
- Outstanding price-performance ratio

Handy Series



	12 VDC 7 A	12 VDC 15 A	24 VDC 6 A *)
Article Number European plug	61112007	61112015	61124006 **)
Article Number UK plug	61112008	61112016	

TECHNICAL SPECIFICATIONS

Input voltage	220 - 240 VAC ± 10 %	220 - 240 VAC ± 15 %	220 - 240 VAC ± 15 %
Input current	0.9 A	1.5 A	1.8 A
Back current	≤ 1 mA	≤ 1 mA	≤ 1 mA
Charge voltage	13.7 - 15 VDC	13.7 - 15 VDC	26.5 - 28.8 VDC
Charging voltage supply mode	13.7 VDC	13.7 VDC	27.2 VDC
Charge current	max. 7 A	max. 15 A	max. 6 A
Ripple voltage	max. 70 mV	max. 70 mV	max. 70 mV
Ambient temperature	-40 up to 50°C	-40 up to 50°C	-25 up to 50°C
Cooling	Convection	Convection	Convection
Charge characteristics	Five steps IUUIU + float	Five steps IUUIU + float	Three step IUUIU + float
Forced Float	13.7 VDC	13.7 VDC	27.2 VDC
Battery types ***)	AGM, GEL, Lead acid	AGM, GEL, Lead acid	AGM, GEL, Lead acid
Battery capacity	1 - 150 Ah (max. 180 Ah)	20 - 300 Ah (max. 360 Ah)	10 - 300 Ah (max. 360 Ah)
Battery cable length	1500 mm	1500 mm	1500 mm
Power cable length	1400 mm	1400 mm	1400 mm
European plug	IEC60884	IEC60884	IEC60884
UK plug	BS1363	BS1363	BS1363
Dimensions (W x D x H) in mm	225 x 50 x 50	325 x 60 x 65	155 x 43 x 80
International Protection rating	IP54	IP54	IP65
Weight	0.5 kg	0.8 kg	1.4 kg

Handy | Clamps
Art. Nr. 61112911



Handy | Fixed Installation
Art. Nr. 61112901



*) no build-in flashlight

**) Fixed mounting

***) with automatic discharge /charge cycles

Graph illustrating multi-step charge algorithm

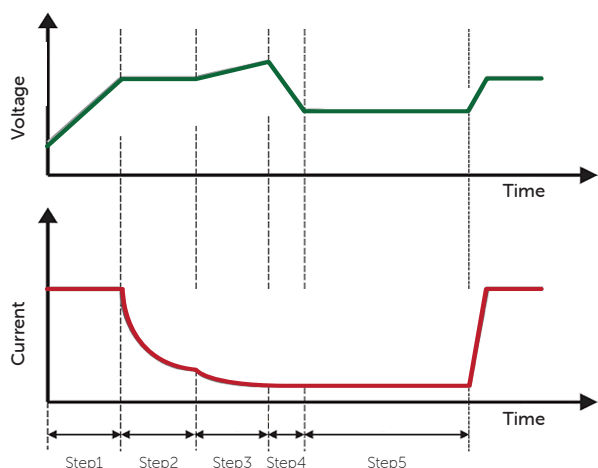

Plug and Play battery chargers

Applications

Charging 12 VDC	Charging 24 VDC
• Starter battery	• Starter battery
• Service battery	• Service battery
• Back-up battery	• Back-up battery



Multifunctional DC-DC converters

In most electrical systems both 12 VDC and 24 VDC equipment is used. **WhisperPower Switched Mode DC -DC converters takes a particular voltage, for example 24 VDC, and convert it in to another DC voltage, for example 12 VDC. The Switched Mode technology ensures minimal energy loss and high output. Our range is based on three different topologies.**



Features and Benefits

- Minimal energy loss thanks to Switched-Mode technology (> 90 % efficiency)
- High quality industrial design for high reliability and longer life cycle
- Silent - no humming, only temperature controlled fans for cooling
- No interference with radios, VHF or other sensitive equipment
- Compact, fast and easy to install
- Excellent price - performance ratio

Converter MCC 24 / 12 - 20 20 Amps with three step charge characteristic

Aluminum heatsink

High efficient switched-mode technology

Can be used in parallel

Fast-connect

Bus-connectable

Marine grade covers

External screw-based installation (wall/floor mounting)



Essential
building
blocks



MC Series

Go to Page 24

- DC-DC converters with common negative
- Step down from 24 VDC to 12 VDC
- Electronic process, high efficiency, low heat output
- Power rating up to 30 A
- Cannot be used in parallel



MCC Series

Go to Page 25

- DC-DC charge converter with current limitation
- Designed to convert 24 VDC to 12 VDC and/or to charge 12 VDC batteries
- Multi step charge characteristics, programmable
- Delivered with temperature sensor as standard
- Can be used as dimming device for DC lighting



MG Series

Go to Page 26/27

- DC-DC converters with galvanic isolation
- Step down from 24 VDC or 48 VDC to 12 VDC
- Step up from 12 VDC to 24 VDC is also possible
- Electronic process, high efficiency, low heat output
- Power rating up to 30 A
- Can be run in parallel for high-demand appliance



DC/DC Converters Common Ground MC Series



	12-24 VDC 10 A	24-12 VDC 5 A	24-12 VDC 8 A	24-12 VDC 12 A	24-12 VDC 20 A	24-12 VDC 30 A
Article Number	60110017	60110005	60110010	60110016	60110011	60110012
TECHNICAL SPECIFICATIONS						
Converter type	Voltage step up and stabilization	Voltage step down and stabilization	Voltage step down and stabilization	Voltage step down and stabilization	Voltage step down and stabilization	Voltage step down and stabilization
INPUT						
Nominal input voltage	12 VDC	24 VDC	24 VDC	24 VDC	24 VDC	24 VDC
Input range, specifications	9 - 18 VDC	18 - 35 VDC	18 - 35 VDC	18 - 35 VDC	18 - 35 VDC	18 - 35 VDC
Input range, no defects	0 - 18 VDC	0 - 35 VDC	0 - 35 VDC	0 - 35 VDC	0 - 35 VDC	0 - 35 VDC
OUTPUT						
Nominal output voltage	25 VDC	13.8 VDC	13.8 VDC	13.8 VDC	13.8 VDC	13.8 VDC
Voltage adjustable	no	no	no	no	no	no
Output accuracy	3 %	3 %	3 %	3 %	1 %	1 %
Ripple, peak output voltage	3 %	1 %	1 %	1 %	1 %	1 %
Maximum power output	300 W	70 W	110 W	170 W	350 W	490 W
Continuous output power	250 W	70 W	110 W	170 W	280 W	420 W
Maximum output current	12 A	5 A	8 A	12 A	25 A	35 A
Continue output current	10 A	5 A	8 A	12 A	20 A	30 A
Continuous output current at 40°C	up to 10 A	up to 5 A	up to 8 A	up to 12 A	up to 20 A	up to 30 A
GENERAL						
Efficiency	> 93 %	> 92 %	> 92 %	> 92 %	> 92 %	> 92 %
Consumption no load	< 5 mA	< 5 mA	< 5 mA	< 5 mA	< 25 mA	< 25 mA
Ambient operating temperature	-10 up to 40°C	-10 up to 40°C	-10 up to 40°C	-10 up to 40°C	-10 up to 40°C	-10 up to 40°C
Storage temperature	-25 up to 85°C	-25 up to 85°C	-25 up to 85°C	-25 up to 85°C	-25 up to 85°C	-25 up to 85°C
Relative humidity in use	up to 95 %, non-condensing	up to 95 %, non-condensing	up to 95 %, non-condensing	up to 95 %, non-condensing	up to 95 %, non-condensing	up to 95 %, non-condensing
Galvanic isolation	Common negative	Common negative	Common negative	Common negative	Common negative	Common negative
Cooling	Convectional	Convectional	Convectional	Convectional	Convectional	Mechanical
PROTECTIONS						
Current / short circuit	Yes / fuse	Yes / fuse	Yes / fuse	Yes / fuse	Restricted by current rating	Restricted by current rating
Overheating, shut down	No	No	No	No	Power restricted by temperature	Power restricted by temperature
MECHANICAL SPECIFICATIONS						
Faston in/off, maximum thread thickness	6 mm ²	6 mm ²	6 mm ²	6 mm ²	6 mm ²	6 mm ²
Dimensions (W x D x H) in mm	88 x 50 x 126	88 x 50 x 70	88 x 50 x 98	88 x 50 x 98	88 x 50 x 126	88 x 50 x 151
Mounting holes (mm)	dia 4 mm, rh 58 x 118	dia 4 mm, rh 58 x 90	dia 4 mm, rh 58 x 90	dia 4 mm, rh 58 x 90	dia 4 mm, rh 58 x 118	dia 4 mm, rh 58 x 143
Weight	360 g	270 g	270 g	290 g	440 g	500 g
International Protection rating	IP20	IP20	IP20	IP20	IP20	IP20
Housing	frame 5	frame 4	frame 4	frame 4	frame 5	frame 6
Housing material	Anodized Aluminum, ABS end caps	Anodized Aluminum, ABS end caps	Anodized Aluminum, ABS end caps	Anodized Aluminum, ABS end caps	Anodized Aluminum, ABS end caps	Anodized Aluminum, ABS end caps
Housing colour	RAL 9011 graphite black	RAL 9011 graphite black	RAL 9011 graphite black	RAL 9011 graphite black	RAL 9011 graphite black	RAL 9011 graphite black

Meets the following Standards

EN61000-6-3 (EN55022), EN61000-6-2 (EN61000-2/3/4, EN61000-4-3), LVD 2006/95/EC (EN60335-1), Automotive EMC 2004/104/EC, RoHS 2011/65/EU Note: The above specifications are subject to change without prior notice.

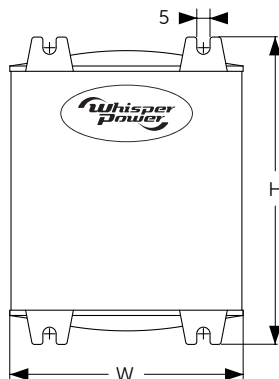
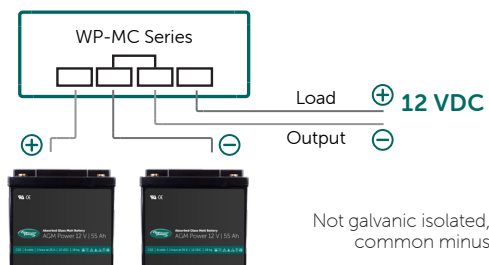

Diagram MC Series



DC-DC B2B Chargers Common ground MCC Series



12-12 VDC | 16 A 24-12 VDC | 5 A 24-12 VDC | 20 A

Article Number 60110014 60201023 60110015

TECHNICAL SPECIFICATIONS

Converter type Voltage stabilised 3-step charge Voltage step down and stabilization Voltage step down and stabilization 3-step 12 VDC battery charger, light dimmer function

INPUT

Nominal input voltage	12 VDC	24 VDC	24 VDC
Input range, specifications	9 - 18 VDC	24 - 32 VDC	24 - 32 VDC
Input range, no defects	0 - 18 VDC	0 - 35 VDC	0 - 35 VDC

OUTPUT

Nominal output voltage	12 VDC	13.8 VDC	13.6 VDC
Voltage adjustable	13.8 Float VDC 14.4 Boost VDC	12 - 15 VDC	12 - 15 VDC
Output accuracy	1 %	2 %	2 %
Ripple, peak output voltage	1 %	1 %	1 %
Maximum power output	200 W	70 W	300 W
Continuous output power	200 W	70 W	270 W
Maximum output current	16 A	5 A	20 A
Continue output current	16 A	5 A	20 A
Continuous output current at 40°C	up to 16 A	up to 5 A	up to 20 A

GENERAL

Efficiency	> 90 %	> 92 %	> 90 %
Consumption no load	17 mA	< 5 mA	< 30 mA
Ambient operating temperature	20°C	-10 up to 40°C	-10 up to 40°C
Storage temperature	-25 up to 85°C	-25 up to 85°C	-25 up to 85°C
Relative humidity in use	up to 95 %, non-condensing	up to 95 %, non-condensing	up to 95 %, non-condensing
Galvanic isolation	Common negative	Common negative	Common negative
Cooling	Convexional	Convexional	Mechanical

PROTECTIONS

Current / short circuit	Yes / fuse	Restricted by current rating	Restricted by current rating
Overheating, shut down	Yes	Power restricted by temperature	Power restricted by temperature

MECHANICAL SPECIFICATIONS

Faston in /off, maximum thread thickness	6 mm ²	6 mm ²	6 mm ²
Dimensions (W x D x H) in mm	88 x 58 x 175	88 x 50 x 98	123 x 66 x 191
Mounting holes (mm)	dia 4 x 6.3 mm Faston	dia 4 mm, rh 58 x 90	dia 4 mm, rh 91 x 177
Weight	613 g	270 g	955 g
International Protection rating	IP20	IP20	IP20
Housing	Yes	frame 4	frame 8
Housing material	Anodized Aluminum, ABS end caps	Anodized Aluminum, ABS end caps	Anodized Aluminum, ABS end caps
Housing colour	RAL 9011 graphite black	RAL 9011 graphite black	RAL 9006 blank Aluminum

Meets the following Standards EN61000-6-3 (EN55022), EN61000-6-2 (EN61000-2/3/4, EN61000-4-3), LVD 2006/95/EC (EN60335-1), Automotive EMC 2004/104/EC, RoHS 2011/65/EU
Note: The above specifications are subject to change without prior notice.



Diagram MCC Series

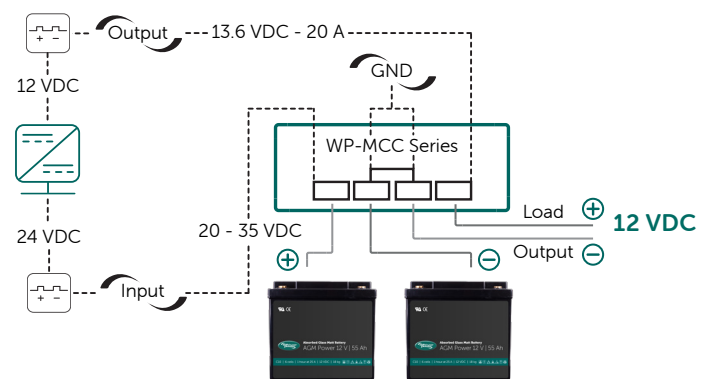



DC/DC converters Galvanic Isolated

MG Series



	12-12 VDC 8 A -i	12-12 VDC 30 A -i	24-12 VDC 3 A -i	24-12 VDC 16 A -i
Article Number	60110019	60110026	60110030	60110020
TECHNICAL SPECIFICATIONS				
Converter type	Voltage stabilization	Voltage stabilization	Voltage step down and stabilization	Voltage step down and stabilization
INPUT				
Nominal input voltage	12 VDC	12 VDC	24 VDC	24 VDC
Input range, specifications	9 - 18 VDC	9 - 18 VDC	20 - 35 VDC	20 - 35 VDC
Input range, no defects	0 - 18 VDC	0 - 18 VDC	0 - 35 VDC	0 - 35 VDC
OUTPUT				
Nominal output voltage	12.5 VDC	12.5 VDC	12.5 VDC	12.5 VDC
Voltage adjustable	Yes	Yes	Yes	Yes
Output accuracy	3 %	3 %	3 %	3 %
Ripple, peak output voltage	1 %	1 %	1 %	1 %
Maximum power output	110 W	490 W	38 W	200 W
Continuous output power	110 W	420 W	36 W	200 W
Maximum output current	8 A	30 A	3 A	16 A
Continue output current	8 A	30 A	3 A	16 A
Continuous output current at 40°C	up to 8 A	up to 30 A	up to 3 A	up to 16 A
GENERAL				
Efficiency	> 87 %	> 87 %	> 87 %	> 87 %
Consumption no load	<2.5 mA	< 25 mA	< 25 mA	< 25 mA
Ambient operating temperature	-10 up to 40°C	-10 up to 40°C	-10 up to 40°C	-10 up to 40°C
Storage temperature	-25 up to 85°C	-25 up to 85°C	-25 up to 85°C	-25 up to 85°C
Relative humidity in use	up to 95 %, non-condensing	up to 95 %, non-condensing	up to 95 %, non-condensing	up to 95 %, non-condensing
Galvanic isolation	Yes, 500 VAC	Yes, 500 VAC	Yes, 500 VAC	Yes, 500 VAC
Cooling	Mechanical	Mechanical	Mechanical	Mechanical
PROTECTIONS				
Current / short circuit	Restricted by current rating	Restricted by current rating	Restricted by current rating	Restricted by current rating
Overheating, shut down	Power restricted by temperature	Power restricted by temperature	Power restricted by temperature	Power restricted by temperature
MECHANICAL SPECIFICATIONS				
Faston in / off, maximum thread thickness	6 mm ²	6 mm ²	6 mm ²	6 mm ²
Dimensions (W x D x H) in mm	88 x 50 x 151	133 x 83 x 186	88 x 50 x 85	88 x 50 x 176
Mounting holes (mm)	dia 4 mm, rh 58 x 143	dia 4 mm, rh 91 x 177	dia 4 mm, rh 58 x 168	dia 4 mm, rh 58 x 168
Weight	630 g	1400 g	250 g	630 g
International Protection rating	IP20	IP20	IP20	IP20
Housing	frame 6	frame 8	frame 7	frame 7
Housing material	Anodized Aluminum, ABS end caps	Anodized Aluminum, ABS end caps	Anodized Aluminum, ABS end caps	Anodized Aluminum, ABS end caps
Housing colour	RAL 9011 graphite black	RAL 9006 blank Aluminum	RAL 9011 graphite black	RAL 9011 graphite black
Meets the following standards	EN61000-6-3 (EN55022), EN61000-6-2 (EN61000-2/3/4, EN61000-4-3), LVD 2006/95/EC (EN60335-1), Automotive EMC 2004/104/EC, RoHS 2011/65/EU Note: The above specifications are subject to change without prior notice			





24-12 VDC 30 A -i	24-24 VDC 15 A -i	48-12 VDC 8 A -i	48-12 VDC 30 A -i
60110021	60110025	60110024	60110023
Voltage step down and stabilization	Voltage stabilization	Voltage step down and stabilization	Voltage step down and stabilization
24 VDC	24 VDC	48 VDC	48 VDC
20 - 35 VDC	20 - 35 VDC	30 - 60 VDC	30 - 60 VDC
0 - 35 VDC	0 - 35 VDC	0 - 70 VDC	0 - 70 VDC
12.5 VDC	12.5 VDC	12.5 VDC	12.5 VDC
Yes	Yes	Yes	Yes
3 %	3 %	3 %	3 %
1 %	1 %	1 %	1 %
400 W	400 W	200 W	400 W
360 W	360 W	100 W	360 W
32 A	16 A	16 A	32 A
30 A	15 A	8 A	30 A
up to 30 A	up to 15 A	up to 8 A	up to 30 A
> 87 %	> 87 %	> 87 %	> 87 %
< 25 mA	< 25 mA	< 25 mA	< 25 mA
-10 up to 40°C	-10 up to 40°C	-10 up to 40°C	-10 up to 40°C
-25 up to 85°C	-25 up to 85°C	-25 up to 85°C	-25 up to 85°C
up to 95 %, non-condensing	up to 95 %, non-condensing	up to 95 %, non-condensing	up to 95 %, non-condensing
Yes, 500 VAC	Yes, 500 VAC	Yes, 500 VAC	Yes, 500 VAC
Mechanical	Mechanical	Mechanical	Mechanical
Restricted by current rating	Restricted by current rating	Restricted by current rating	Restricted by current rating
Power restricted by temperature	Power restricted by temperature	Power restricted by temperature	Power restricted by temperature
6 mm ²	6 mm ²	6 mm ²	6 mm ²
133 x 83 x 186	133 x 83 x 186	88 x 50 x 151	133 x 83 x 186
dia 4 mm, rh 91 x 177	dia 4 mm, rh 91 x 177	dia 4 mm, rh 58 x 143	dia 4 mm, rh 91 x 177
1400 g	1400 g	630 g	1400 g
IP20	IP20	IP20	IP20
frame 8	frame 8	frame 6	frame 8
Anodized Aluminum, ABS end caps	Anodized Aluminum, ABS end caps	Anodized Aluminum, ABS end caps	Anodized Aluminum, ABS end caps
RAL 9006 white Aluminum	RAL 9006 blank Aluminum	RAL 9011 graphite black	RAL 9006 white Aluminum

EN61000-6-3 (EN55022), EN61000-6-2 (EN61000-2/3/4, EN61000-4-3), LVD 2006/95/EC (EN60335-1), Automotive EMC 2004/104/EC, RoHS 2011/65/EU Note: The above specifications are subject to change without prior notice

Diagram MG Series

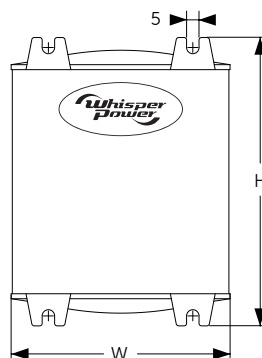
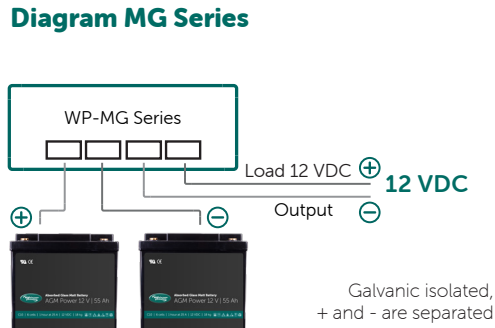



Inverters & Inverter / Charger Combinations

WP-Sine | WPC | Supreme Combi

Not so long ago, diesel or gasoline generators were the only option to deliver AC power at locations without public grid. The invention of the Sine Wave Inverter has created an attractive alternative to supply AC power from a battery buffer, without the need to start a diesel or gasoline generator. WhisperPower offers a very wide choice of high-quality inverters and inverters with built-in battery charger (Combi's). All these power products can be combined with other building blocks from the WhisperPower catalogue such as solar panels, DC alternators and the small compact generators.

A brief summary of the terms:

- WhisperPower Sine Wave Inverters provide a pure sine wave voltage to which virtually any AC device can be connected
- Up to 3 kVA power, we supply the versions with a subtle orange marking: compact, easy-to-install devices, as Inverter or Combi
- Above 3 kVA power, we offer the Green Label super Inverters and Combi's, intended for large, professional power systems
- All WhisperPower Inverters and Combi's can be connected to analogue or digital remote panels

Sine Wave Inverters

Super Inverters AC PowerCube

[Go to Page 30](#)



Sine Wave Inverters

WP-Sine Series

[Go to Page 34](#)

Inverters

WhisperPower's Sine Wave Inverters convert 12 or 24 VDC battery voltage into exactly the same mains voltage you receive at home. Low power appliances such as vacuum cleaners, computers, phone and tablet chargers do not require a diesel or gasoline generator but can instead be operated by an inverter. With an inverter, any AC Power appliance can be used at any time, without the need of a running generator. WhisperPower inverters are often used in combination with a DC BeltPower alternator, connected to the main engine.



System Combi's WPC Series

Go to Page 38

Smaller generators by 'peak shaving'

Our Supreme Combi and our WhisperPowerCenter (WPC) are both combining an inverter and battery charger. The WPC is a heavy-duty device made to last forever, even non-stop running and under harsh circumstances. We supply units with one AC and two AC inputs (generator/land power) with automatic activation of the active source. Other features: the units can operate in parallel for single or three phase output, the units can operate in parallel with the AC generator and the land / shore line (PowerBoost feature to re-inforce land / generator power), the units can be integrated into a total WhisperPower system with AC generator, with extended monitoring and WhisperCare as an important feature.



Sine Wave Inverter / Battery Chargers Supreme Combi

Go to Page 42



Charger / inverter combinations

When inverters are combined with a battery charger and transfer relay all in one box, we use the term Combi's. WhisperPower's Combi are compact, space saving, robust and extremely powerful. Two versions are available: our Supreme Combi (light weight, switched mode technology) and the WPC 'System Combi' with multiple in outputs.

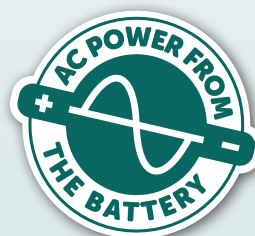



Super Inverters

AC PowerCube

The AC PowerCube is a professional inverter suitable for continuous operation even under extreme conditions. There are three models: an 4 kVA model, an 7 kVA consisting of two 3.5 kVA power modules (built into one enclosure) connected in parallel and providing each other with backup. The 14 kVA model is made up of four 3.5 kVA modules which are redundantly configured.

The AC PowerCubes make it possible to switch off the diesel generator for longer periods time and provide the entire onboard installation with power including, for example, air conditioning, kitchen and refrigeration equipment. As a result, there is less fuel consumption, less noise disruption and less running hours for the generator.

Features

- Industrial electronics based on high frequency switched mode technology
- As a result, high efficiency (> 92 %) and a minimum of power loss
- No ripple effect from AC to battery, with as a result, a stable DC network
- No buzz or humming, super quiet
- Fan cooled, resistant to high ambient temperatures
- Double DC connectors 2 x positive, 2 x negative, can be connected to two battery banks
- Perfect for insertion in a complete WhisperPower system

Benefits

- Uncompromising design: purely as inverter
- Direct power supply, no interruptions, battery as buffer
- Great high efficiency = minimal cooling required (cool running)
- Perfect to combine with DC PowerCube and Genverter®
- Significant cost savings from reduced fuel consumption
- Quiet and environmentally friendly
- Simple to integrate in WhisperPower Hybrid energy system

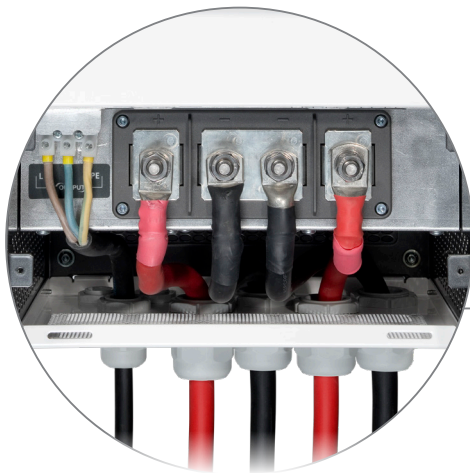

Connection compartment of the AC PowerCube 7 kVA. On the right, double battery connector with 2x DC positive and 2x DC negative connections - one or two separate battery banks can be connected. On the left, the 230 VAC / 50 Hz (60 Hz) output and the connection for the remote control panel and the various set up ports.



Heavy duty inverters

Our AC PowerCube Super Inverter is an extremely powerful and robust device, designed to convert 230 VAC power from a 24 VDC battery bank.

There are three models: with 4 kVA, 7 kVA and 14 kVA output power, single phase 230 VAC output (50 or 60 Hz). 3 phase inverter configurations can be achieved with our WPC, see page 38. For our single phase models, switched mode technology has been applied, resulting in an extremely efficient and "cool running" device.

Professional package

Robust Aluminum enclosure with heavy duty, multiple battery DC connections. Inside electronics is protected against moisture and salty influences by conformal coating.

Built-in redundancy

Our AC PowerCube inverters feature built-in redundancy. We work with power modules of 3.5 kVA each, which operate in parallel. When one power module fails, the inverter will continue to supply power.



 External command
(Phoenix MSTBA2/4 - G-5.08)

 WP-RCP remote control panel, to be connected by RJ12 connector plus cable, for extended LED information and ON-OFF remote switch. Supplied as standard

 WhisperConnect CAN-bus
RJ45 port for integration to the system bus

 USB Type B port, can be used to set output parameters

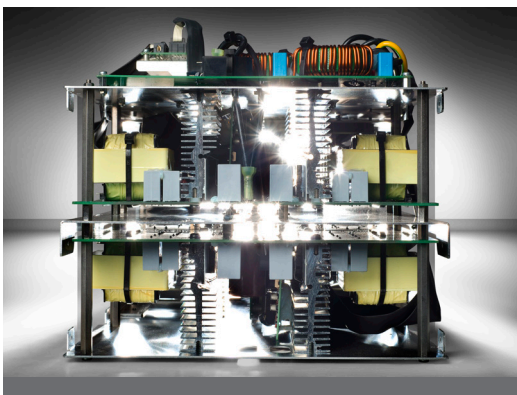

Powerful, economical and extremely reliable

Team WhisperPower has more than 30 years of experience in developing robust power electronics. The AC PowerCube inverters have been developed to provide a stable, clean and uninterruptible 230 VAC / 50 Hz (230 VAC / 60 Hz) to replace the public mains power or a non-stop running generator. These super inverters are unique because of the technology used. Generally, transformer technology is used with this type of power, to convert a 24 or 48 VDC battery voltage to a 230 VAC / 50 Hz AC voltage. Transformer technology has disadvantages: heavy weight, bulky cabinets and high losses in the conversion process. They are in general also more noisy. WhisperPower applies efficient, silent high-frequency switching technology to its all stand-alone inverters. Read more about the advantage on the next page.



Connectivity

Analogue remote controls and cables supplied as standard, digital TOUCH panels optional. WhisperConnect CAN-bus connection for interconnection with other devices and USB interface eventual uploads. Laptop programmable.



Give your battery a lifetime!

As a result of our unique V6 and V12 switched mode technology, no voltage ripple is returned to the DC battery terminals. This ripple effect is reducing battery life time and is causing fluctuations in the DC net (flickering lights for example).

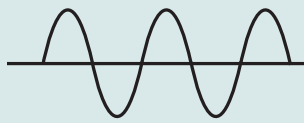

Perfect sine wave

Lowest harmonic distortion under all load circumstances and perfect sine wave. Stable AC output voltage and frequency (quartz controlled).

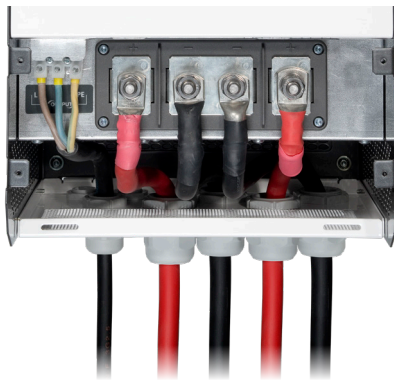

Multiple battery connections

AC PowerCubes can be connected to 2 separate batteries, which allows to take a lot of current at the same time from batteries which are stored in different locations.

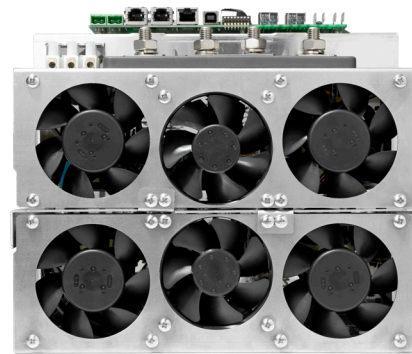

Running cool & no buzzing

Highly efficient switched mode technology applied for our inverter-only products. AC PowerCubes are fitted with temperature controlled silent running fans.

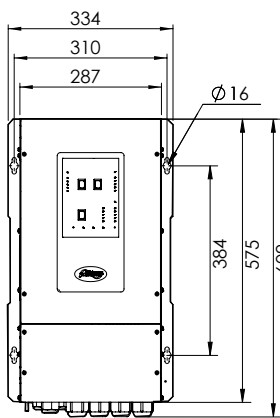

Front view 24 | 4000
24 | 7000

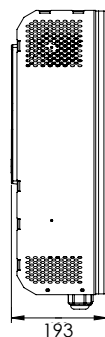

Side view 24 | 4000
24 | 7000

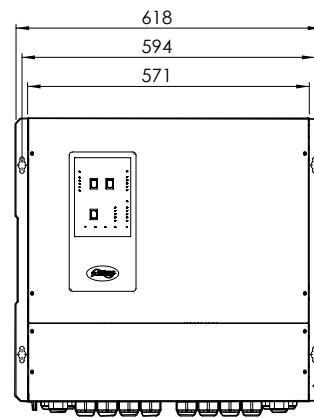

Front view 24 | 14000

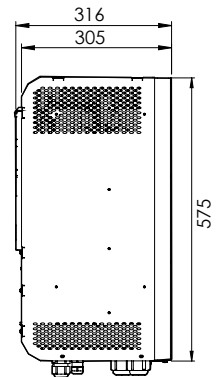

Side view 24 | 14000





AC PowerCube Series

	24 VDC 4000 VA	24 VDC 7000 VA	24 VDC 14000 VA
--	------------------	------------------	-------------------

Article Number	60203003	60203004	60203005
----------------	----------	----------	----------

GENERAL

Nominal output voltage	230 VAC ($\pm 5\%$), Phase, Neutral, Earth	230 VAC ($\pm 5\%$), Phase, Neutral, Earth	230 VAC ($\pm 5\%$), Phase, Neutral, Earth
Nominal output frequency (adjustable to 60 Hz)	50 Hz (± 0.01 Hz)	50 Hz (± 0.01 Hz)	50 Hz (± 0.01 Hz)
Nominal battery voltage	24 VDC	24 VDC	24 VDC
Nominal power P30 (cos phi = 1) (30 minutes at 40°C)	4000 W	7500 W	14000 W
Peak power (20 seconds)	7000 W	15000 W	28000 W
Continuous power (cos phi = 1) (40°C)	3000 W	6000 W	12000 W
AC connection (output)	Internal terminal block, screw terminal (4 - 6 mm ²)		
DC connection	2 x M10	4 x M10	4 x M10 (2 per battery bank)
Minimum capacity of battery bank	260 Ah	600 Ah	800 Ah
Efficiency	> 85 %	> 85 %	> 85 %
Peak efficiency	> 92 %	> 92 %	> 92 %
Dimensions (W x D x H) in mm	334 x 193 x 575	334 x 193 x 575	618 x 316 x 575
Weight	13 kg	18 kg	40 kg
Noise level (at 1 metre)	< 48 dBA	< 48 dBA	< 48 dBA
Indicators	AC present, DC 1 present, DC (1) load, DC 2 present, DC (2) load, AC current, AC voltage		
Safety	Short circuit, overload, overheating, battery voltage too low / high		

TECHNICAL SPECIFICATIONS

Technology	Six-step multiphase flyback, switched mode technology		
Low battery switch OFF	20 VDC (± 0.5 VDC)	19 VDC (± 0.5 VDC)	19 VDC (± 0.5 VDC)
Low battery switch ON	22 VDC (± 0.5 VDC)	22 VDC (± 0.5 VDC)	22 VDC (± 0.5 VDC)
High battery switch OFF	32 VDC (± 0.5 VDC)	32 VDC (± 0.5 VDC)	32 VDC (± 0.5 VDC)
High battery switch ON	30 VDC (± 0.5 VDC)	30 VDC (± 0.5 VDC)	30 VDC (± 0.5 VDC)
Maximum ripple on DC (battery)	5 % RMS	5 % RMS	5 % RMS
Input current (nominal load)	200 A	2 x 200 A	4 x 200 A
Consumption (no load)	< 300 mA, 6 W	< 550 mA, 12 W	< 2 x 550 mA, 24 W
Total harmonic distortion (THD)	< 5 % (normal)	< 5 % (normal)	< 5 % (normal)
Allowable power factor	0 < cos phi < 1	0 < cos phi < 1	0 < cos phi < 1

CONDITIONS

Ambient operating temperature	-20 up to 40°C	-20 up to 40°C	-20 up to 40°C
Storage temperature	-25 up to 80°C (derating above 40 °C)	-25 up to 80°C (derating above 40 °C)	-25 up to 80°C (derating above 40 °C)
Relative humidity	max. 95 %, non-condensing	max. 95 %, non-condensing	max. 95 %, non-condensing
International Protection rating	IP23	IP23	IP23
Cooling	Natural / forced	Natural / forced	Natural / forced

CONFORMITY

EU Directive	EMC Directive 2004/108 / EC, EMC 2004/104 / EC (automotive), Low Voltage Directive 2006/95 / EC		
Standards	EN 55022 (emission) EN 61000-3-2 (harmonic distortion), EN 61000-4-11, EN 61000-3-3 (voltage variations), EN 61000-6-2 (immunity) and EN 60950-1 (safety) AND 68-2-6 (vibration), EN 60945 (navigation and radio communications), UL 458		





Sine Wave Inverters

Sine Series

Sine Inverters provide owners of yachts / motorhomes / cabins with a whole host of possibilities to use all kinds of household appliances - coffee makers, microwave ovens, TVs, computers just name it!



WhisperPower Sine Wave Inverters are perfectly silent 'generators' which supply AC Power from the battery. These modern inverters, from the WP-Sine series, are compact, light, robust and with high efficiency.

They are easy to self-install and do not require maintenance. They are an ideal addition to existing installations which already include a battery charger.

Specifications

- Choice of 500 W, 600 W, 1000 W, 2000 W and 3000 W models
- Can be connected to the 12 VDC (24 VDC) battery
- Plug and Play: AC socket and DC connectors
- Negligible loss during conversion from battery to alternating current
- USB connector on front to charge telephone etc. (separate charger not necessary)
- 200 % peak power
- Remote operation possible, status LEDs on front (DC and AC info)

Benefits

- Pure sine wave power output, stable frequency
- Pure suitable for sensitive devices
- Remarkably compact and lightweight
- Simple to install
- Silent, robust, protected against overheating, over-use, short circuit
- Outstanding price-performance ratio

up to
3 kW
(6 kW peak)



This is what the **Basic system** looks like

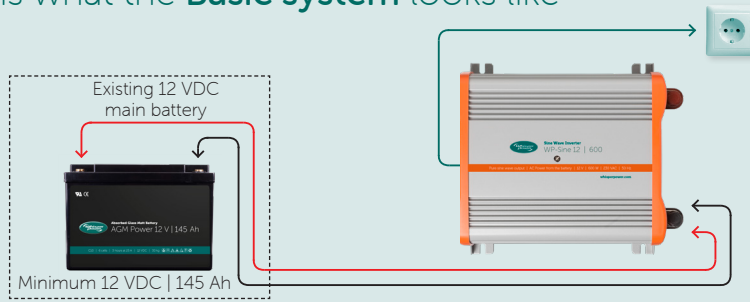

This is what the **Plug and Play system** looks like



This is what the **Comfort system** looks like



Sine Dimensions

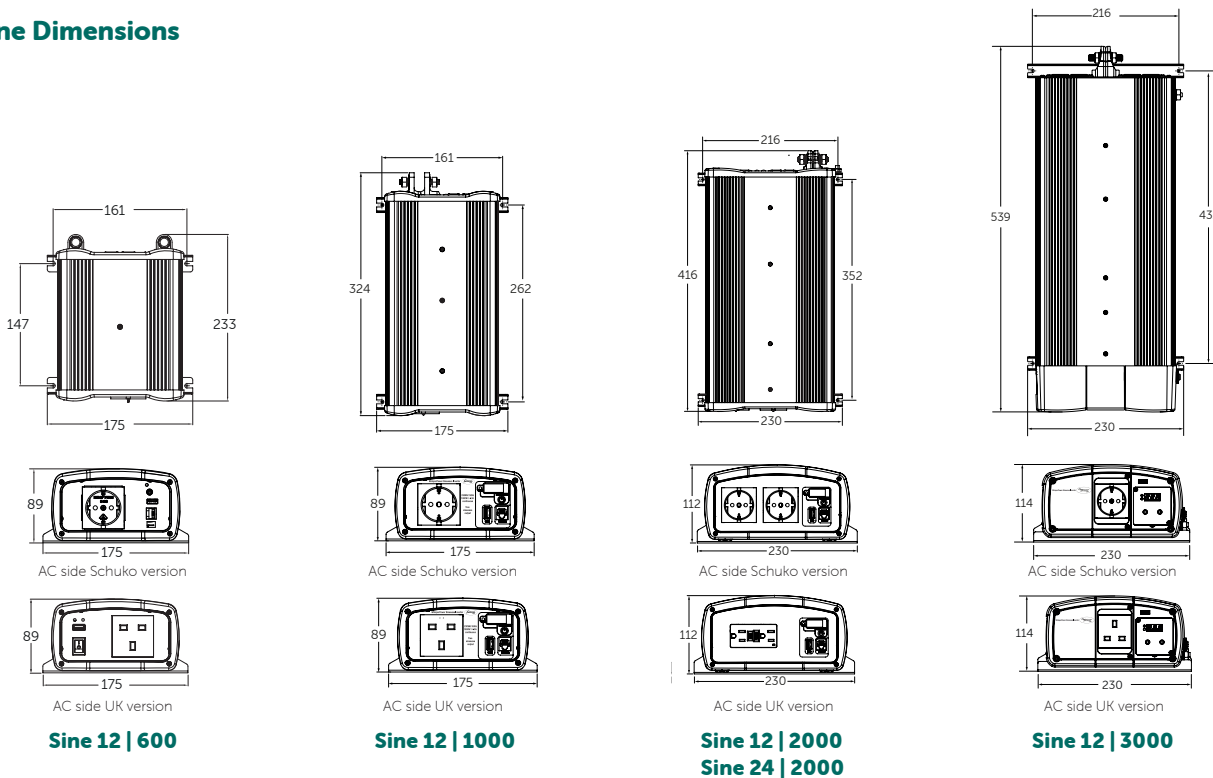



Sine Series

	12 VDC 600 W	12 VDC 1000 W	12 VDC 2000 W
Article Number	61120600	61121500 (Schuko socket) 61121501 (UK socket)	61122500 (Schuko socket) 61122501 (UK socket)
AC OUTPUT			
Power (continuous)	600 W	1000 W	2000 W
Power (peak 500 ms)	800 W	2000 W	4000 W
Output Voltage	230 VAC	230 VAC	230 VAC
Output frequency	50 Hz	50 Hz	50 Hz
Transfer switch	No	No	No
Total harmonic distortion (THD)	< 5 % pure sine wave	< 5 % pure sine wave	< 5 % pure sine wave
DC INPUT			
Nominal battery voltage	12 VDC	12 VDC	12 VDC
Voltage range	10.5 - 15.5 VDC	10.5 - 15.5 VDC	10.5 - 15.5 VDC
Input current	57 A	94 A	187 A
Consumption (no load)	0.8 A typical	0.8 A typical	1.6 A typical
DC OUTPUT			
5 VDC USB Phone charger	1000 mA	2100 mA	2100 mA
DISPLAY			
LED indicator	No	Yes	Yes
Digital display	Input voltage / current, output power	Input voltage / current, output power	Input voltage / current, output power
PROTECTION AND FEATURES			
Warning low input voltage	11.2 VDC	11.2 VDC	11.2 VDC
Shutdown low battery voltage	10.5 VDC	10.5 VDC	10.5 VDC
Recovery after low battery voltage	11.8 VDC	11.8 VDC	11.8 VDC
Shutdown battery voltage too high	15.5 VDC	15.5 VDC	15.5 VDC
Warning too much power	Yes	Yes	Yes
Shutdown too much power	Yes	Yes	Yes
Short circuit too much power	Yes	Yes	Yes
Temperature warning	Yes	Yes	Yes
Thermal protection (shutdown)	Yes	Yes	Yes
Conforms to	EC Council Directive 2004/108/EC Electromagnetic Compatibility Registration No.NTC 1310 406E & E-marking	EC Council Directive 2004/108/EC Electromagnetic Compatibility Registration No.NTC 1310 406E & E-marking	EC Council Directive 2004/108/EC Electromagnetic Compatibility Registration No.NTC 1310 406E & E-marking
Operating temperature range	-20 up to 55°C (derating above 40°C)	-20 up to 55°C (derating above 40°C)	-20 up to 55°C (derating above 40°C)
Relative Humidity	95 %, non-condensing	95 %, non-condensing	95 %, non-condensing
Ventilation	Forced Cooling	Forced Cooling	Forced Cooling
Dimensions (W x D x H) in mm	233 x 89 x 175	324 x 89 x 175	416 x 112 x 230
Weight	1.7 kg	2.9 kg	5.5 kg
Battery connector	Threaded M6 screw	Threaded M6 screw	Threaded M8 screw
Earth terminal	Threaded M6 screw	Threaded M6 screw	Threaded M6 screw
AC-output	1 x Schuko socket or 1x UK socket	1 x Schuko socket or 1 x UK socket	2 x Schuko sockets or 2 x UK sockets
Warranty	5 years	5 years	5 years

Sine Wave Inverter Accessories

ART. NR.	ARTICLE
61121510	Sine Remote Control with 6 metre cable
61121511	Sine 12 1000 1.5 metre battery cable
61121512	Sine 12 2000 1.5 metre battery cable



Sine Wave Inverter
Remote Control
Art. Nr. 50214751





12 VDC 3000 W
61123500 (Schuko socket) 61123501 (UK socket)
3000 W
6000 W
230 VAC
50 Hz
Yes
< 5 % pure sine wave
12 VDC
10.5 - 15.5 VDC
270 A
1.6 A base
2100 mA
Yes
Input voltage / current, output power
11 VDC
10.5 VDC
12 VDC
15.5 VDC
Yes
Yes
Yes
Yes
Yes
EC Council Directive 2004/108/EC Electromagnetic Compatibility Registration No:NTC 1310 406E & E-marking
-20 up to 55°C (derating above 40°C)
95 %, non-condensing
Forced Cooling
539 x 114 x 230
6.9 kg
Threaded M8 screw
Threaded M6 screw
1 x Schuko socket or 1 x UK socket
5 years

24 VDC 500 W	24 VDC 2000 W
61140500	61142500
500 W	2000 W
1000 W	4000 W
230 VAC	230 VAC
50 Hz	50 Hz
No	No
< 5 % pure sine wave	< 5 % pure sine wave
24 VDC	24 VDC
21 - 31 VDC	21 - 31 VDC
23 A	94 A
0.4 A base	1.6 A base
N/A	2100 mA
Yes	No
Input voltage / current, output power	Input voltage / current, output power
22.4 VDC	22.4 VDC
21 VDC	21 VDC
23.6 VDC	23.6 VDC
31 VDC	31 VDC
Yes	Yes
Yes	Yes
Yes	Yes
Yes	Yes
Yes	Yes
EC Council Directive 2004/108/EC Electromagnetic Compatibility Registration No:NTC 1310 406E & E-marking	EC Council Directive 2004/108/EC Electromagnetic Compatibility Registration No:NTC 1310 406E & E-marking
-20 up to 55°C (derating above 40°C)	-20 up to 55°C (derating above 40°C)
95 %, non-condensing	95 %, non-condensing
Forced Cooling	Forced Cooling
200 x 89 x 175	416 x 112 x 230
1.7 kg	5.5 kg
Threaded M6 screw	Threaded M6 screw
Threaded M6 screw	Threaded M6 screw
1 Schuko socket	2 x Schuko sockets or 2 x UK sockets
5 years	5 years



Sine Wave Inverter
12 | 3000
Control Panel
Art. Nr. 50214751

Available with different plug sockets



Australia,
China



USA

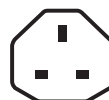

UK



Europe



System Combi's WPC Series

Our WhisperPower Center is the ultimate inverter / charger for multifunctional energy systems. It is one of the most efficient and powerful inverters available on the market with 94 % yield and peak capacity 300 %.

The WPC can be paired to any WhisperPower Genverter® AC generator using the generator input. The AC outputs can then be connected in parallel allowing the generator power or mains connection to be supplemented with the power from the inverter!

The WPC units can also be used without a generator, operating as the main AC power supply device, incorporating a battery charging function in case mains or generator power is available.

38



Key Functions

- Combined high class Sine Wave Inverter and battery charger
- AC Genset and grid power input, high/low power AC output
- Seamless integration with WhisperPower or other AC gensets
- Automatic seamless transfer to the active AC consumers in the output
- Parallel (stacking) to increase AC output power up to 9 units
- Paralleling to obtain three phase power (3 x 380 VAC 50 Hz)
- Power support modus, parallel-to-grid to reinforce weak grid power

Smart System Features

- The WPC will boost the AC inverter power in case of limited land / genset power
- Power Sharing: Battery charging will be automatically reduced when AC load rises
- In addition the WPC's inverter will boost the output of the generator or land power supply by using power from the battery
- In case of land power "only" and low battery, the WhisperPower generator will start automatically to avoid severe battery discharge





Advanced Parallel Functions

- Up to nine WPC's can operate in parallel to achieve higher power output
- Three phase or split phase operation is also possible
- Available for both European and American voltage / frequency

Advanced Touch Panel

Advanced WhisperTouch 7 inch Monitor and Control panel for local read-out (LAN) or remotely via the internet from anywhere in the world, using WhisperCare. Access can be from a phone, tablet, laptop or PC for multiple operating systems. Total system control including battery monitoring, WhisperPower generator control, etc. See page 122 for more information.

Two AC inputs & two AC outputs

- The WPC can be connected to two independent AC sources, for example land power and an AC generator. The WPC will automatically connect to the active source
- The main (inverter) output has a seamless, no-break functionality. In the event of land power disconnect or mains failure, the WPC takes over the power provision to the connected loads. Computers and other electronic equipment will continue to operate without interruption
- 2nd high power output is activated when land power/ genset power is available
- WPC includes automatic start / stop function based on low battery, can be activated through the touch panel

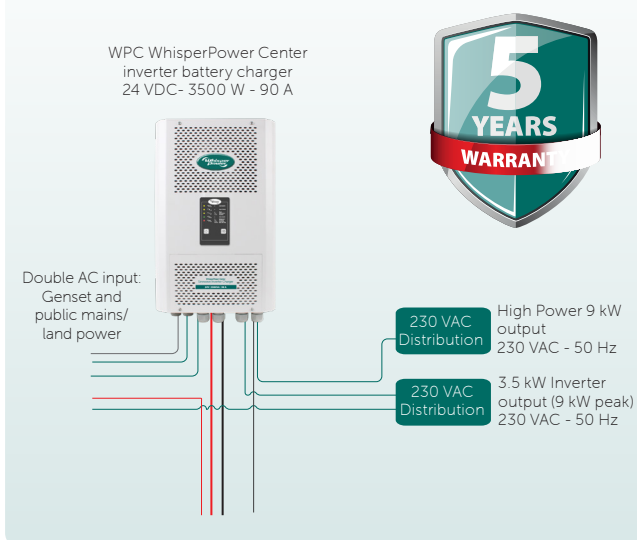



WhisperPower Center (Single Input) Series

	12 VDC 2000 VA *)	12 VDC 3000 VA	24 VDC 3500 VA *)	24 VDC 5000 VA	48 VDC 4000 VA *)	48 VDC 6000 VA	48 VDC 8000 VA
Article Number	60201301**)	60201315	60201302**)	60201006**)	60201303**)	60201317	60201004
TECHNICAL SPECIFICATIONS							
Nominal battery voltage	12 VDC	12 VDC	24 VDC	24 VDC	48 VDC	48 VDC	48 VDC
Input voltage range	9.5 - 17 VDC	9.5 - 17 VDC	19 - 34 VDC	19 - 34 VDC	38 - 68 VDC	38 - 68 VDC	38 - 68 VDC
Continuous power at 25°C	2000 VA	2500 VA	3000 VA	4500 VA	3500 VA	5000 VA	7000 VA
Power 30 minutes at 25°C	2000 VA	3000 VA	3500 VA	5000 VA	4000 VA	6000 VA	8000 VA
Power 5 seconds at 25°C	3x Pcont.	3x Pcont.	3x Pcont.	12 kVA	15 kVA	15 kVA	21 kVA
Maximum load	Fully protected up to short circuit						
Maximum asymmetric load	Up to continuous power						
Cos phi	0.1 - 1	0.1 - 1	0.1 - 1	0.1 - 1	0.1 - 1	0.1 - 1	0.1 - 1
Maximum efficiency	93 %	93 %	94 %	94 %	96 %	96 %	96 %
Consumption OFF / standby / ON	1.4 / 1.6 / 9 W	1.8 / 2.1 / 14 W	1.4 / 1.6 / 12 W	1.8 / 2.1 / 14 W	1.8 / 2.1 / 14 W	1.8 / 2.1 / 22 W	1.8 / 2.1 / 30 W
Output voltage	Pure sine wave 230 VAC (±2 %) - 120 VAC / 60 Hz available as well						
Output frequency	50 Hz ± 0.05 % (crystal controlled; adjustable to 60 Hz)						
Harmonic distortion (sine)	< 2 % THD	< 2 % THD	< 2 % THD	< 2 % THD	< 2 % THD	< 2 % THD	< 2 % THD
Overload protection and short circuit	Switches itself off after 3 start attempts						
Overheating protection	Warning, followed by shutdown and automatic restart						
BATTERY CHARGER							
Charge characteristics	Multi-step: bulk-absorption-float, Suitable for all types of batteries						
Maximum charger current	100 A	160 A	90 A	140 A	50 A	100 A	120 A
Temperature Compensation	With WhisperPower temperature sensor WPC-BTS						
Power factor correction	61000 - 3 - 2	61000 - 3 - 2	61000 - 3 - 2	61000 - 3 - 2	61000 - 3 - 2	61000 - 3 - 2	61000 - 3 - 2
GENERAL SPECIFICATIONS							
Input voltage range	184 - 250 VAC	184 - 250 VAC	184 - 250 VAC	184 - 250 VAC	184 - 250 VAC	150 - 250 VAC	184 - 250 VAC
Input frequency	50 / 60 Hz (45 / 65 Hz)	50 / 60 Hz (45 / 65 Hz)	50 / 60 Hz (45 / 65 Hz)	50 / 60 Hz (45 / 65 Hz)	50 / 60 Hz (45 / 65 Hz)	50 / 60 Hz (45 / 65 Hz)	50 / 60 Hz (45 / 65 Hz)
Max. input current (switching relay)/ Max. output current	30 A / 50 A	50 A / 56 A	30 A / 45 A	50 A / 56 A	30 A / 47 A	50 A / 56 A	50 A / 80 A
Transfer time	< 15 ms	< 15 ms	< 15 ms	< 15 ms	< 15 ms	< 15 ms	< 15 ms
Weight	25 kg	34 kg	28 kg	40 kg	28 kg	42 kg	46 kg
Dimensions (W x D x H) in mm	326 x 144 x 540	300 x 230 x 497	326 x 144 x 540	300 x 230 x 497	326 x 144 x 540	500 x 300 x 230	300 x 230 x 497
International Protection rating	IP21	IP21	IP21	IP21	IP21	IP21	IP21
Colour	RAL 9003	RAL 9003	RAL 9003	RAL 9003	RAL 9003	RAL 9003	RAL 9003
Conforms to	EMC Directive 2004/108/EC : EN 61000-6-1, EN 61000-6-3,						
Operating temperature range	-20 up to 40°C (power reduction 40 to 55°C)						
Relative humidity (during operation)	95 %, non-condensing						
Cooling	Temp. controlled fan above 45°C						
Noise level	< 40 dB / < 45 dB (without / with cooling)						
Warranty	5 years						

WhisperPower Center (Dual Input) Series

12 VDC 2000 VA	24 VDC 3500 VA	48 VDC 4000 VA
60201001 *)	60201002 *)	60201003 *)
100 A - 230 VAC	90 A - 230 VAC	50 A - 230 VAC
50 - 60 Hz	50 - 60 Hz	50 - 60 Hz
Dual AC input / output	Dual AC input / output	Dual AC input / output

*) Designed for use with Whisper Piccolo / SQ / Genverter®, dual input - also available with single input

**) Also available as 120 VAC 60 Hz models (single input only)

Important Accessories / Related Products



ART. NR. 60201032
WPC
Communication Cable 15 m



ART. NR. 60201082
WPC-BSI 500
Battery Status Interface



ART. NR. 60201084
WPC-RS232-i Data Logger Module
with SD memory card



ART. NR. 60201021
WPC
Slave Charger 24 VDC | 5 A



ART. NR. 40280101
WhisperTouch 7 inch screen

Go to Page 134

Go to Page 136

Go to Page 128

Plug and Play

- Auto start stop connection (see also WPC – BSI)
- Connection for Temperature Sensor (to be put on battery)
- WPC Bus interface connection to WhisperTouch
- Connection for RS 232 Data Logger Module

Easy to install

- As standard supplied with 2 metre of marine grade DC cables
- Hard wiring connection of all AC & DC connections
- Optional plug-in slave charger of 5 A, three step
- External holes for wall mounting

Safety first

- Galvanic input to output separation
- Earth stud
- Completely protected against overload and over-temperature



AC output
DC input > Connection
Gen/Grid/Inv.



WPC-Dimensions

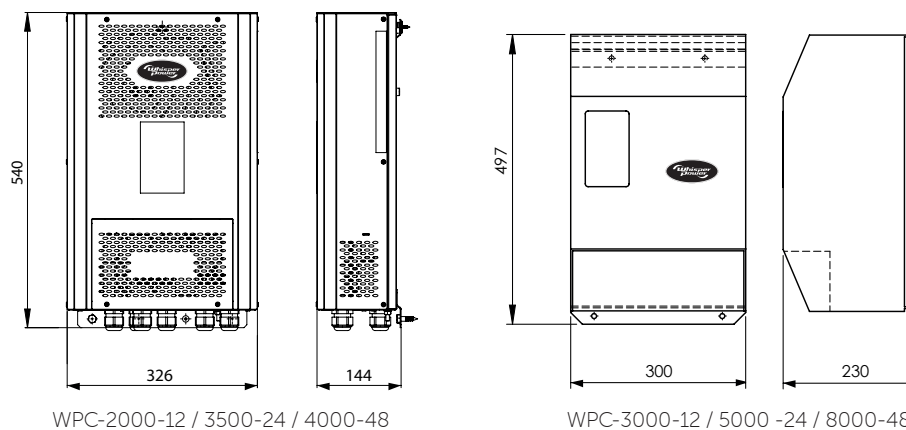

Sine Wave Inverter / Battery Charger

Supreme Combi

Due to its efficient and compact design, the Supreme Combi inverter/charger is suitable for installation in tight spaces. This device provides all the required comfort expected on yachts, motorhomes or cabins. All AC devices can be connected and work without issue such as a coffee machine, kettle, kitchen appliances, TV, computer etc. The multi-stage battery charger can handle any AC generator as well as the land power connection.

42



Features / Benefits

- Convert 12 VDC battery power to 230 VAC alternating current
- Sine wave output power is ideal for demanding electrical motors, sensitive electronics and rechargeable devices
- Multi-stage charger ensures batteries are charged safely and efficiently
- Suitable for small microwaves, computers, televisions power tools and more
- Detachable control display
- Land power control button
- Ideal for self installation



System Example One-stop-shop

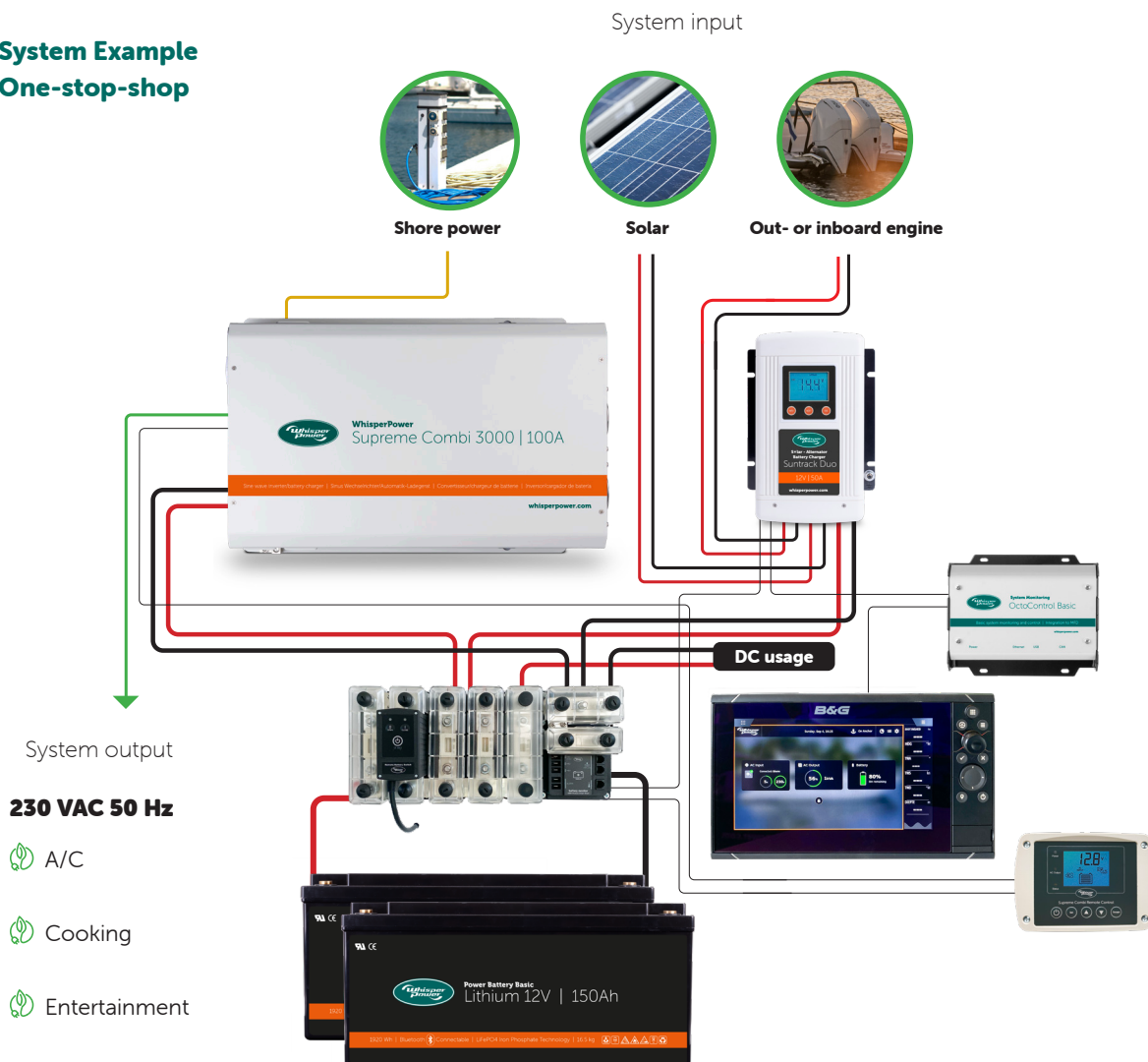



	12 VDC 2000 VA 80 A	12 VDC 3000 VA 100 A	24 VDC 2000 VA 40 A	24 VDC 3000 VA 50 A
--	-------------------------	--------------------------	-------------------------	-------------------------

Article Number	61122080	61123001	61242040	61124001
----------------	----------	----------	----------	----------

RUNNING AS INVERTER

Supreme Combi Series

AC Output Power	2000 W	3000 W	2000 W	3000 W
AC Output Current	8.7 A	13 A	8.7 A	13 A
AC Surge Power (Peak)	4000 W	6000 W	4000 W	6000 W
AC Output Voltage/Frequency	230 VAC / 50 Hz	230 VAC / 50 Hz	230 VAC / 50 Hz	230 VAC / 50 Hz
AC Output Waveform	Sine Wave (< 3% THD)	Sine Wave (< 3% THD)	Sine Wave (< 3% THD)	Sine Wave (< 3% THD)
Nominal DC Input Voltage	12.5 VDC	12.5 VDC	25 VDC	25 VDC
No Load battery draw (Inverter Mode)	< 3.5 A	< 3.5 A	< 1.8 A	< 1.8 A
DC Input Voltage operating range	10.5 – 16.5 VDC	10.5 – 16.5 VDC	21 - 33 VDC	21 - 33 VDC
Under Voltage Alarm	11 - 12.5 VDC	11 - 12.5 VDC	22 - 25 VDC	22 - 25 VDC
Under Voltage Alarm Recovery	11.5 - 13 VDC	11.5 - 13 VDC	23 - 26 VDC	23 - 26 VDC
Under Voltage Shutdown	10.5 - 12 VDC	10.5 - 12 VDC	21 - 24 VDC	21 - 24 VDC
Under Voltage Recovery	11.5 - 13 VDC	11.5 - 13 VDC	23 - 26 VDC	23 - 26 VDC
Over Voltage Shutdown / Recovery	16.5 / 16 VDC	16.5 / 16 VDC	33 / 32 VDC	33 / 32 VDC

AC TRANSFER SWITCH

Transfer Time	< 30 ms	< 30 ms	< 30 ms	< 30 ms
Transfer Relay Rating	16 A	16 A	16 A	16 A
AC Input Source Setting	4, 6, 8, 10, 12, 13, 14, 16 A	4, 6, 8, 10, 12, 13, 14, 16 A	4, 6, 8, 10, 12, 13, 14, 16 A	4, 6, 8, 10, 12, 13, 14, 16 A
AC Output Hardwire (max.)	16 A	16 A	16 A	16 A
AC Output Socket (max.)	16 A-EU, 13 A-UK, 10 A-AU	16 A-EU, 13 A-UK, 10 A-AU	16 A-EU, 13 A-UK, 10 A-AU	16 A-EU, 13 A-UK, 10 A-AU

DISPLAY

Display Port	RJ12	RJ12	RJ12	RJ12
Inverter Mode	Battery Voltage, DC Current, AC Output Power	Battery Voltage, DC Current, AC Output Power	Battery Voltage, DC Current, AC Output Power	Battery Voltage, DC Current, AC Output Power
Charger Mode	Charging Voltage, Charging Current, AC Input Power	Charging Voltage, Charging Current, AC Input Power	Charging Voltage, Charging Current, AC Input Power	Charging Voltage, Charging Current, AC Input Power

RUNNING AS BATTERY CHARGER

Charging Voltage Range	13.8 - 14.8 VDC	13.8 - 14.8 VDC	27.6 - 29.6 VDC	27.6 - 29.6 VDC
Float Voltage Range	13 - 14 VDC	13 - 14 VDC	26 - 28.8 VDC	26 - 28.8 VDC
Recharge Voltage Range	12.8 - 14 VDC	12.8 - 14 VDC	25.6 - 28 VDC	25.6 - 28 VDC
Bulk Charge Current Range	10 - 80 A	25 - 100 A	5 - 40 A	10 - 50 A
Absorption-Float Current Range	2 - 15 A	2 - 20 A	2 - 6 A	2 - 8 A
Battery Type	AGM, GEL, Lead acid and Lithium	AGM, GEL, Lead acid and Lithium	AGM, GEL, Lead acid and Lithium	AGM, GEL, Lead acid and Lithium
Charge Cycle Stages	Bulk / Absorption / Float / Recharge	Bulk / Absorption / Float / Recharge	Bulk / Absorption / Float / Recharge	Bulk / Absorption / Float / Recharge
Maintenance Recharge Cycle	7 days	7 days	7 days	7 days
Power Factor Correction	> 95 %	> 95 %	> 95 %	> 95 %
Efficiency	> 80 %	> 80 %	> 80 %	> 80 %

SAFETY AND ENVIRONMENTAL

Conformance	LVD: EN/IEC 62040-1, IEC 61558-2-16	LVD: EN/IEC 62040-1, IEC 61558-2-16	LVD: EN/IEC 62040-1, IEC 61558-2-16	LVD: EN/IEC 62040-1, IEC 61558-2-16
EMI/EMC	EMC: EN/IEC 62040-2, Category C1	EMC: EN/IEC 62040-2, Category C1	EMC: EN/IEC 62040-2, Category C1	EMC: EN/IEC 62040-2, Category C1
Agency Markings	CE	CE	CE	CE
Operating Temperature	0 to 40°C (32 to 104°F)	0 to 40°C (32 to 104°F)	0 to 40°C (32 to 104°F)	0 to 40°C (32 to 104°F)
Storage Temperature	-20 to 60°C (-4 to 140°F)	-20 to 60°C (-4 to 140°F)	-20 to 60°C (-4 to 140°F)	-20 to 60°C (-4 to 140°F)
Relative Humidity	5 - 90 % non-condensing	5 - 90 % non-condensing	5 - 90 % non-condensing	5 - 90 % non-condensing
Operating Altitude	Up to 9.843 ft (3000 m) above sea level	Up to 9.843 ft (3000 m) above sea level	Up to 9.843 ft (3000 m) above sea level	Up to 9.843 ft (3000 m) above sea level

WEIGHT AND DIMENSIONS

Weight	8 kg / 17.6 lb	10.4 kg / 22.9 lb	8 kg / 17.6 lb	10.4 kg / 22.9 lb
Dimensions (W x D x H) in mm	391 x 106 x 302	500 x 106 x 307	391 x 106 x 302	500 x 106 x 307
Dimensions (W x D x H) in inches	15.4 x 4.2 x 11.9	19.7 x 4.2 x 12.1	(15.4 x 4.2 x 11.9	19.7 x 4.2 x 12.1

Note: specifications are subject to change without notices.

System monitoring

Supreme Combi System (12 VDC)

WhisperPower is now getting ready for the 12 VDC systems market.

We supply all the components that allow private or business users to easily assemble and install their own system. The components are selected in such way the system is safe and in compliance with the local standards.

The diagram below shows a system with a set of WhisperPower Lithium batteries, connected to the Supreme Combi 12 | 2000.

Main themes when installing Lithium batteries: optimum safety, switching off at a certain discharge level and protection against

overcharging and overloading. The new WhisperCare monitoring and communication program is now underway, allowing to read out all essential system parameters on a third party touch panel, a cell phone or a tablet by connecting the relevant devices to the OctoControl Gateway.

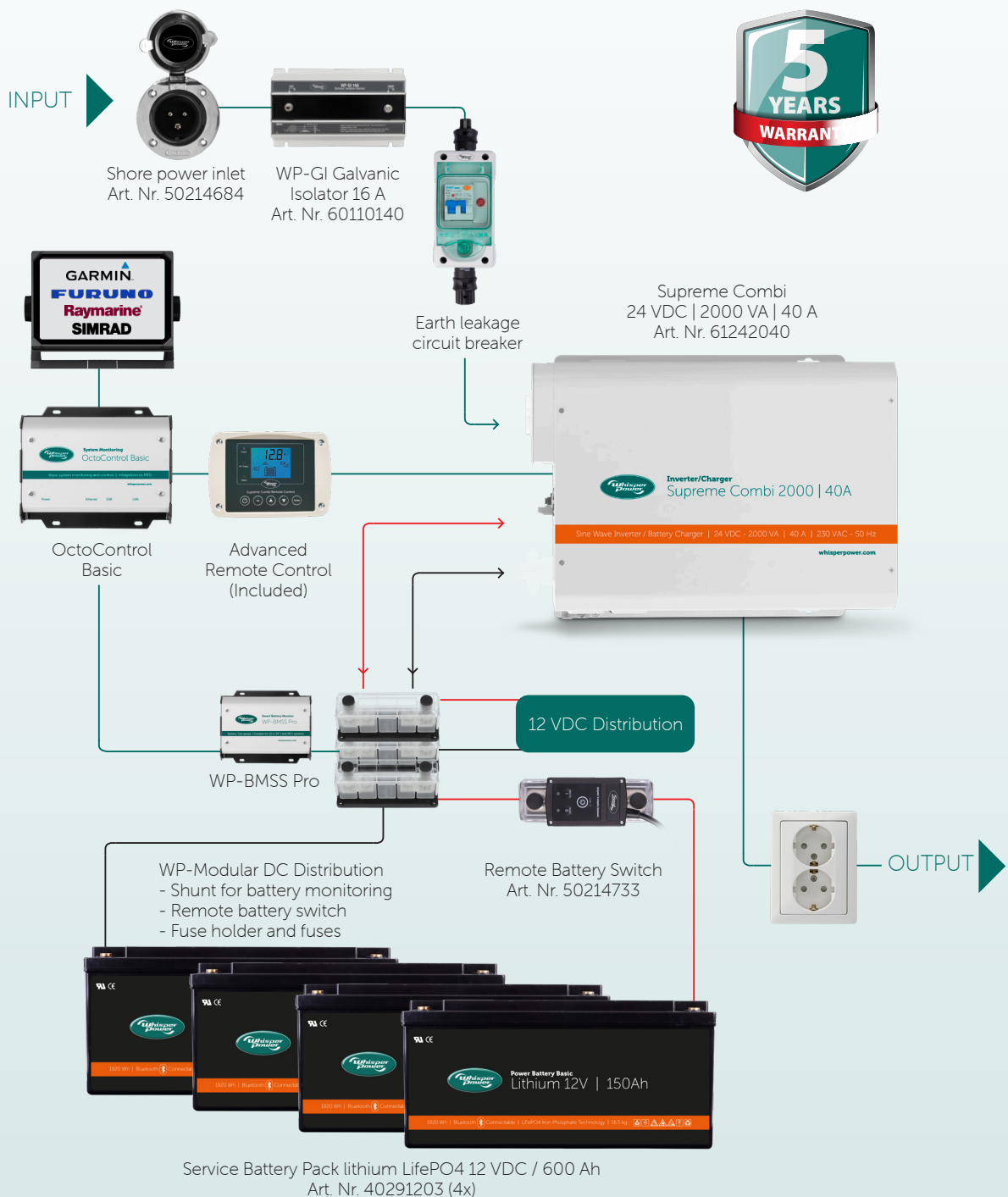

Remote monitoring and control

2 Variations

Gateway

For consumers with single device system

More info about the Gateway
Go to Page 130

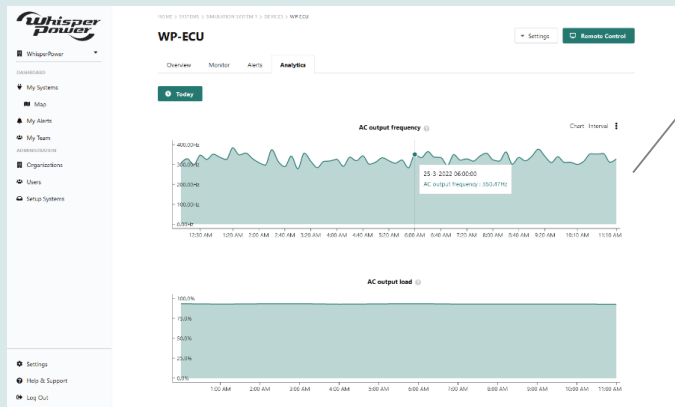
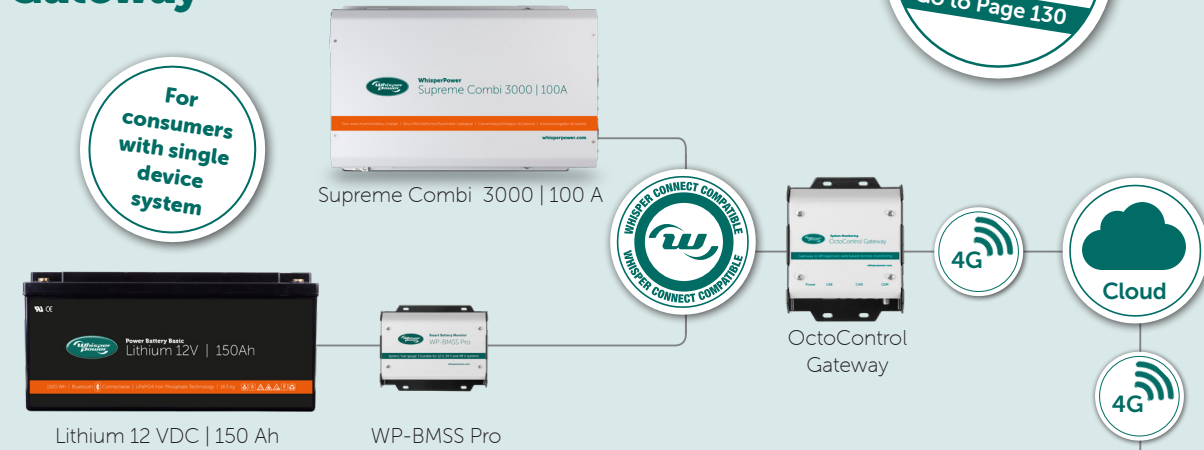

Extended WhisperCare cloud based read-out

- OctoControl Gateway connects to cellphone, tablet etc.
- Real time and historical information of essential functions
- ON-OFF control remotely

Basic

More info about the Basic
Go to Page 130

Supreme Combi 12 VDC | 3000 VA | 100 A

Suntrack Duo 12 VDC | 50 A

WP-BMSS Pro (2x)



Basic WhisperCare

- OctoControl Basic connects WhisperPower's Touch screen (5 / 7 Inch)
- OctoControl Basic connects to a third party screen

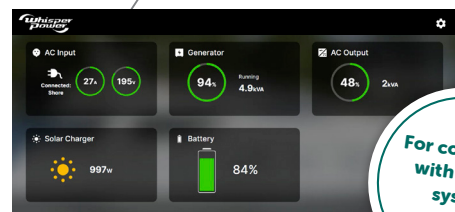

For consumers with a basic system and MFDs

Pre- assembled

All-in-one solution

Battery-based power system for the provision of AC power. Consists of one power electronics module and one or two Lithium battery packs. All components have been pre-installed/assembled in the WhisperPower factory.

This unit is supplied as an easy Plug and Play installation, with connections to: AC power (land) input, solar panel(s) input, connection to outboards or inboard starter battery or vehicle starter battery. The maximum charge power from this source is 1 kW (100 Amps / 12 VDC). There are outlets for 230 VAC and (optional) 12 VDC.

Applications

Diesel or gasoline generator replacement, 230 VAC 50 Hz (120 VAC 60 Hz) power source for:

- Air conditioning, 6.000 – 16.000 Btu.
- Electric hob, cooking, oven, microwave, entertainment
- Coffee machine (Nespresso, Dolce Gusto, Senseo), water cooker
- Various household equipment, cell phone / laptop chargers, etc.

46

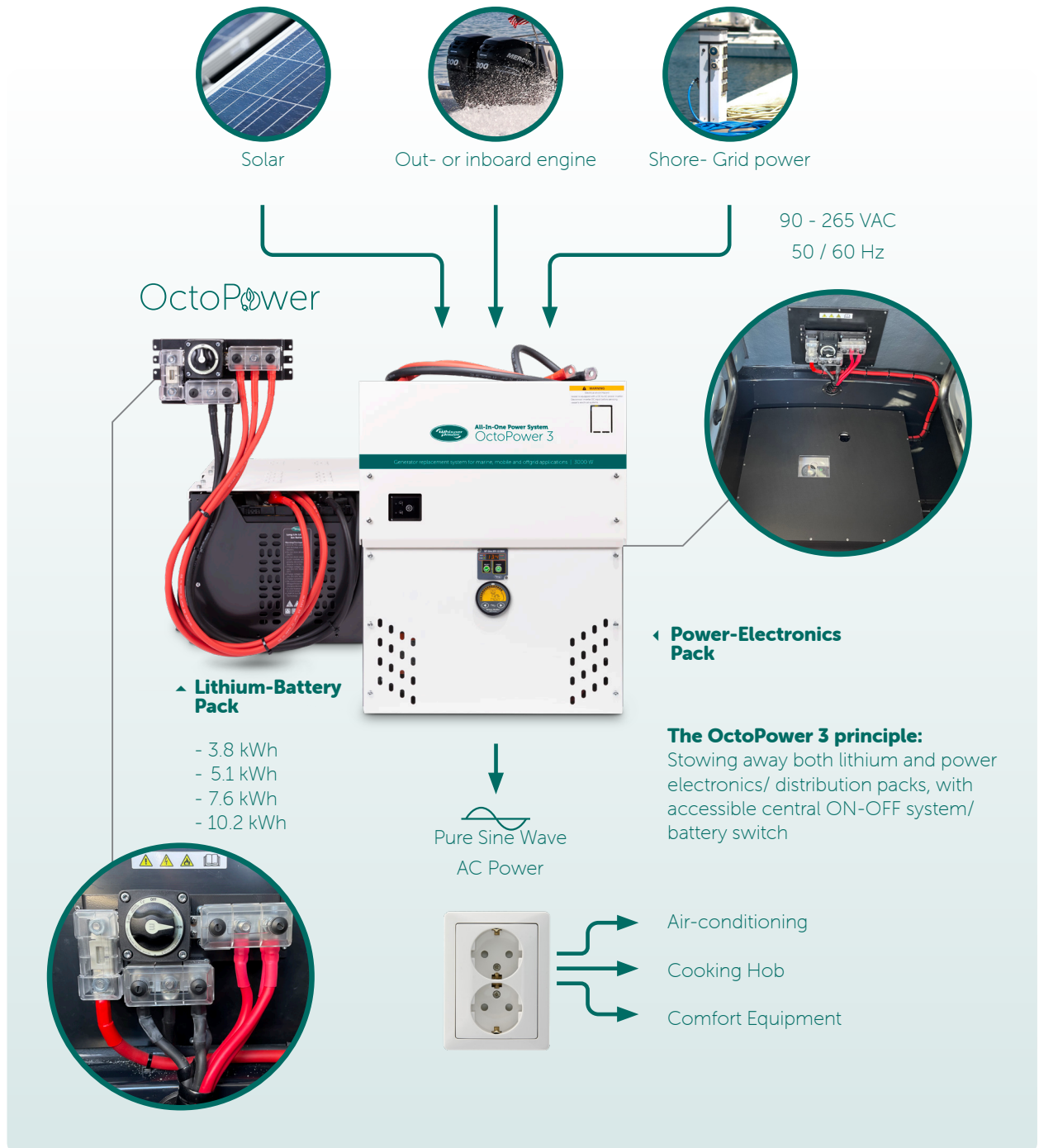

OCTOPOWER 3000 W | ALL-IN-ONE

Indoor / Outdoor	Indoor
Article number	42001210 230 VAC / 50 Hz 42001215 120 VAC / 60 Hz

GENERAL SYSTEM SPECIFICATIONS	
Inverter power / zero-emission modus	3 kVA (6 kVA peak)
Inverter output voltage / Hz	230 VAC 50 Hz \pm 0.01% 120 VAC 60 Hz \pm 0.01%
DC charging / grid input	60 A
AC voltage / grid input (or auxiliary genset)	90 – 265 VAC, 47 – 63 Hz

DC SYSTEM SPECIFICATIONS	
Battery type	Power Battery Basic 2000-4000 cycles
DC voltage	12 VDC
Battery charger output	60 A
Solar charger output MPPT	1 x 50 A - 12 VDC
DC-DC booster / converter	2 x 50 A - 12 VDC = 100 A
Power sharing / DC control	N/A
Connectable to	2 Outboard engines, 2 inboards

SINE WAVE INVERTER SPECIFICATIONS	
Model	WP-Sine 12 / 3000
Power rating	0 – 6000 VA max., 3 kVA cont. at 25°C
Stand-by consumption	1.6 W
Efficiency	93 %
Power of transfer switch	3 kW

BATTERY SPECIFICATIONS	
Battery chemistry	Lithium Basic LiFe Po4
Capacity in kWh (Selectable)	3.8 - 5.1 - 7.6 - 10.2 kWh
Nominal voltage	12 VDC

MONITORING & CONTROL READ OUT	
Panel model & size	WBM Battery Monitor - Smart Shunt
Read-out information	DC V/A/Time remaining / SOC
Remote monitoring via UTP / Router / Cell Phone	With Whisperpower App

MECHANICAL SPECIFICATIONS (MODULAR VERSION)	
Battery Pack Dimensions (W x D x H) in mm	488 x 300 x 750 (5.1 kWh)
Power Electronics Pack Dimensions (W x D x H) in mm	480 x 277 x 601
Specifications may be changed without prior notice	

OPTIONAL	
Article number	42001201
OctoPower 3	Optional DC Output kit

BATTERY PACK TO BE SELECTED ***)	
Article number	Module
42001230	OctoPower - Battery Module 12 VDC / 300 Ah - 3840 Wh Lithium
42001240	OctoPower - Battery Module 12 VDC / 400 Ah - 5120 Wh Lithium
42001260	OctoPower - Battery Module 12 VDC / 600 Ah 7680 Wh Lithium (2 modules of 300 Ah)
42001290	OctoPower - Battery Module 12 VDC / 800 Ah 10.240 Wh Lithium (2 modules of 400 Ah)

*) 5 years on power electronics
 **) Battery warranty according warranty term sheet
 ***) Battery packs can be used to power up one of our other inverters or Combi's – see page 42
 Optional solar package – see page 34

Power electronics pack *)

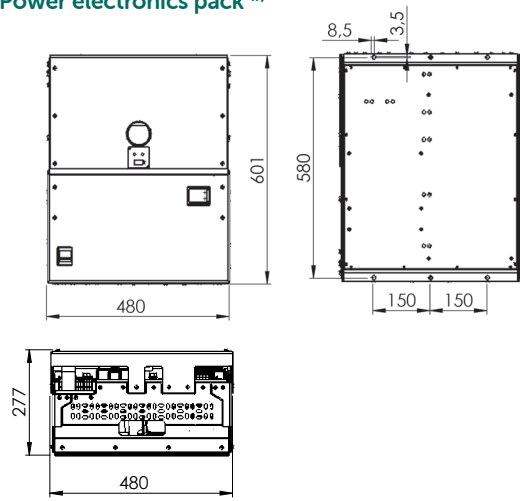

Battery pack **)

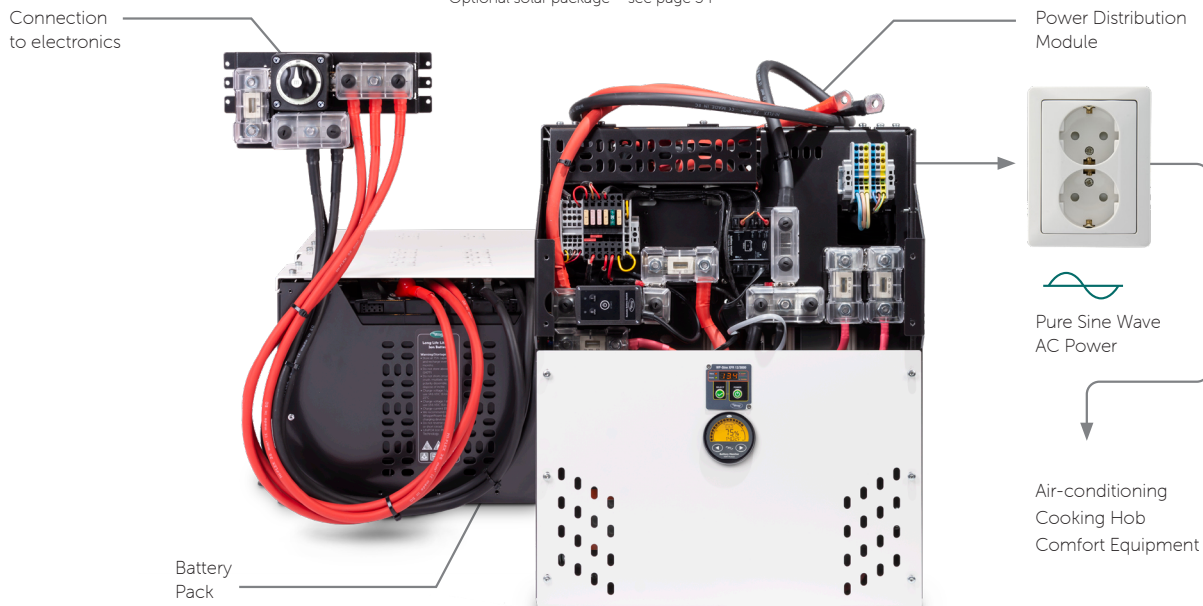
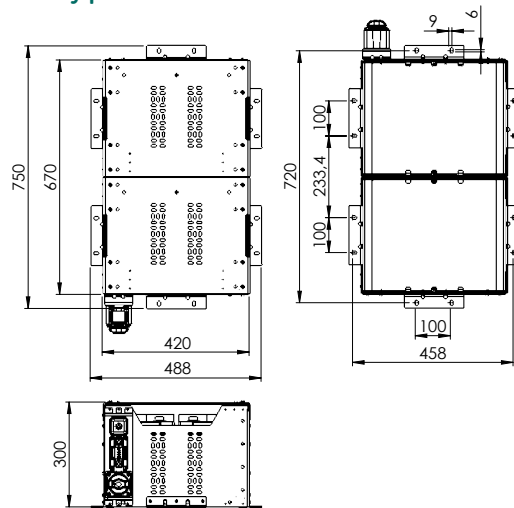

Power Generation

Solar

What could be better than drawing free energy from the sun?

WhisperPower offers a wide range of high efficiency solar panels for installation on vehicles, vessels or land-based objects. Both flexible panels that can be glued to a surface and panels for mounting on a console. All installation accessories including charge controllers are available which exemplifies our one-stop-shop concept.



WhisperPower Solar Panels

Go to Page 50

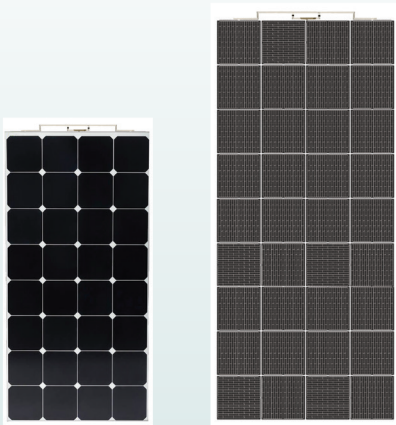

High Class Flexible solar panels which can be glued/sticked on a surface

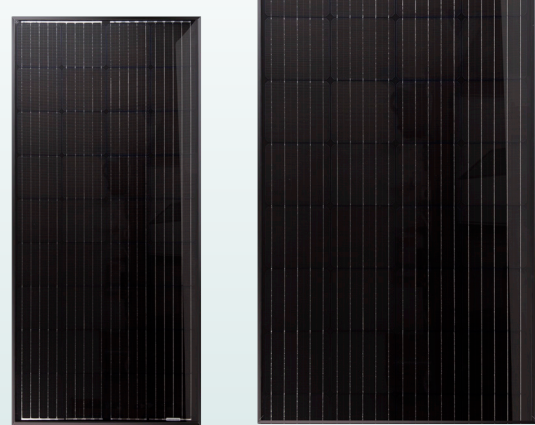

Robust rigid high efficient solar panels

WhisperPower High yield charge controllers based on MPPT technology

Starting on Page 54



Power Generation

Alternators

In many marine and mobile situations, there is an auxiliary engine that can be used to produce additional power. WhisperPower provides a wide range of alternators that can be connected to the main engine: for 12, 24 VDC and 230 VAC, 50 Hz.

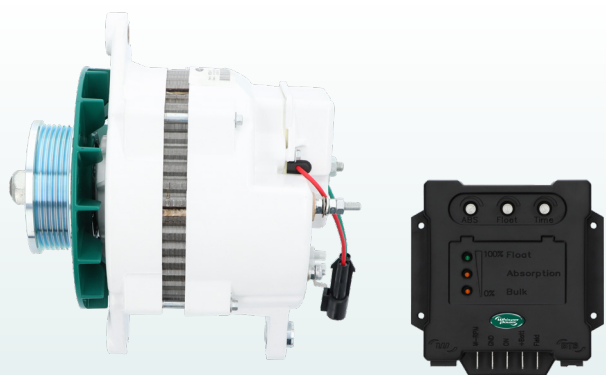

Using the onboard engine as a generator DC BeltPower

[Go to Page 58](#)

Alternators

Your WhisperPower dealer will be pleased to advise you on the choice of the correct alternator and voltage regulator. For DC alternators, it is important to correctly install the regulator (ACR) in the system. The mounting brackets will have to be prepared by the dealer. This is valid for both DC and AC alternator systems.

230 VAC directly from the engine AC BeltPower

[Go to Page 60](#)



WhisperPower Solar Panels

For cases when energy consumption is limited, purchasing and installing solar panels can be a good solution for providing onboard electrical power. The actual yield is determined by the type of panel, its dimensions, the geographical location and the position of the panel in relation to the sun.



In general, solar panels are used as the power source for basic power requirements and maintenance of the battery. If a land power connection is not available, the solar panels act as the means to keeping the battery under voltage. The yield of the panels is specified in Watts-peak. This is the maximum power and not a constant output.

General features solar panels

- Quality panels from European manufacturers
- Power ranges: 104, 124, 186 Wp and 195, 330 Wp
- Available in: All black monocrystalline or blue polycrystalline
- The panels conform to important standards such as VDE and MCS, and can withstand salt air



Visit to calculate the yield of a panel

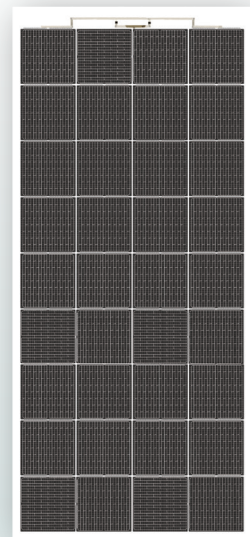
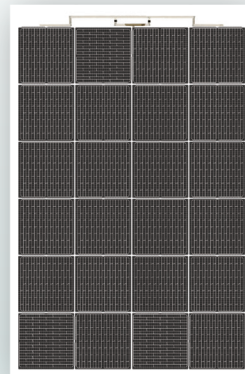

WhisperSolar Flex Series

	104 Wp TOP CLASS	124 Wp FIRST CLASS	186 Wp FIRST CLASS
Article Number	60110437	60110438	60110441

Flexible panels with walkable top layer

- For fixed mounting (sealant) on deck, dock house or motorhome
- Or mounting on railing or rigging (fixing eyes)
- No rear ventilation necessary
- Panels can be walked on

WhisperSolar Flex 104 / 124 / 186 Wp

Monocrystalline modules with thin, light weight and compact cells. Panel can be bent with a maximum radius of 10 cm. These panels are designed for marine and mobile applications and are therefore, wind, water and corrosion resistant. Ideal for charging an 12 or 24 VDC battery. All panels can be supplied with a single-stage regulator. When used for charging AGM or GEL batteries, we recommend installing a multi-stage regulator. The WhisperSolar Flex panels are fitted with DC wires on the back for deck-thru mounting.

Rigid panels with glass top layer

- Monocrystalline or polycrystalline technology
- For fixed mounting in a frame
- 195 and 330 Wp models
- Rear ventilation required
- Cannot be walked on
- MPPT controller available

WhisperSolar panels for fixed mounting

The non-flexible panels for permanent installation are extensively used for the marine, mobile and offgrid markets. The price per watt / peak is much more favourable than the specialist "walk on" panels such as the Flex models. The range is made in Europe by a high level manufacturing company. The product range is of very high-quality and meets the highest standards.

We only use industrial grade cells guarantee long life and high efficiency

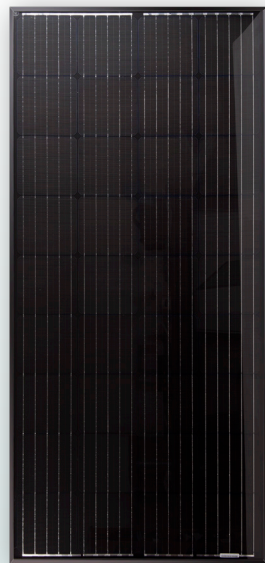

195 Wp

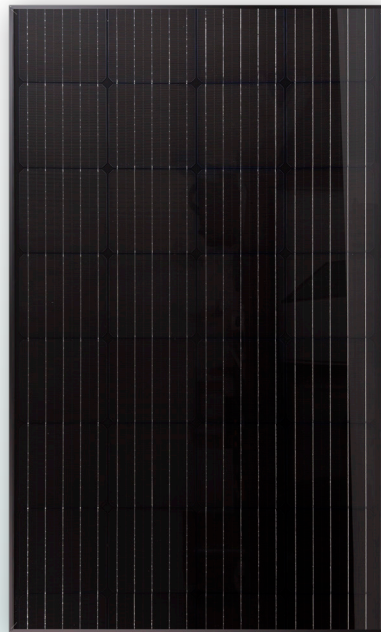

330 Wp

WhisperSolar Series

Article Number

60110402

60110439



Complete Solar Kit

Solar Charge Controller (starting from page 54)

- Install between panel and battery
- Suntrack regulators with and without MPPT technology
- MPPT= Maximum Power Point Tracking converting extra voltage in to charge current. Increases system efficiency by approximately 30 %
- Three step charge process from 15 Amps so suitable for AGM and GEL batteries
- Most Suntrack models are also suitable for Lithium batteries

WhisperSolar Flex Series

104 Wp | TOP CLASS

124 Wp | FIRST CLASS

186 Wp | FIRST CLASS

60110437

60110438

60110441

MAIN SPECIFICATIONS

Maximum power [W] Wp	104 Wp	124 Wp	186 Wp
Dimensions (W x D x H) in mm	1109 x 546 x 2	1046 x 683 x 2	1523 x 683 x 2
Weight	1.4 kg / 3.1 lb	1.7 kg / 3.7 lb	2.4 kg / 5.3 lb
Maximum power Voltage Vmp	18.2 VDC	12.6 VDC	19.6 VDC
Maximum power Current Imp	5.7 A	9.5 A	9.5 A
Open circuit voltage Voc	21.8 VDC	16 VDC	24 VDC
Short circuit current Isc	6 A	9.8 A	9.8 A
NOCT	45 ± 2 °C	45 ± 2 °C	45 ± 2 °C
Operating temperature	-40 up to 85 °C	-40 up to 85 °C	-40 up to 85 °C
Temp. coeff. Pmax. [%/°C]	-0.38	-0.38	-0.40
Temp. coeff. Voc [%/°C]	-0.27	-0.27	-0.32
Temp. coeff. Isc [%/°C]	0.05	0.05	0.05
Columns x Rows (cells n°)	4 x 8 (32)	4 x 6 (24)	4 x 9 (36)
Maximum system voltage	1000 VDC	1000 VDC	1000 VDC
Maximum reverse current	12 A	12 A	12 A
Safety class	A	A	A



52

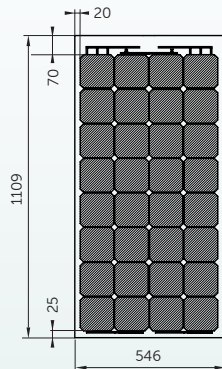

WhisperSolar Flex
104 Wp | Top Class
Art. Nr. 60110437

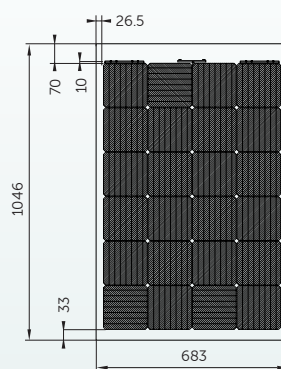

WhisperSolar Flex
124 Wp | First Class
Art. Nr. 60110438

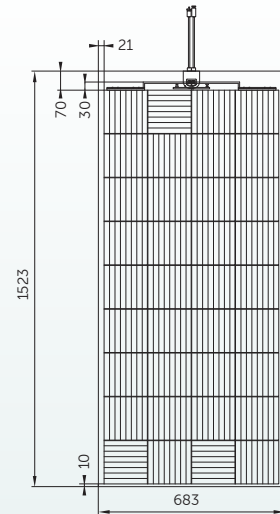

WhisperSolar Flex
186 Wp | First Class
Art. Nr. 60110441

Electrical Characteristics

104 Wp | Top Class

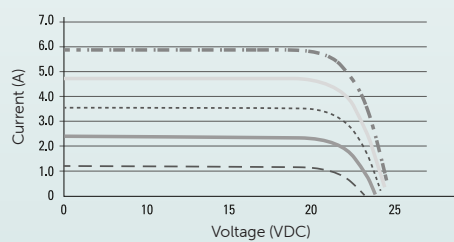

124 Wp | First Class /
186 Wp | First Class

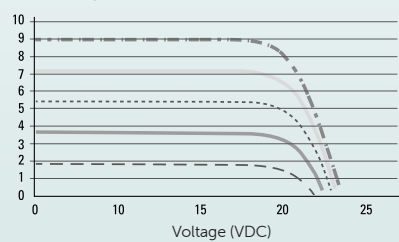

- 100 W/m²
- - - 200 W/m²
- 400 W/m²
- · · 600 W/m²
- 800 W/m²
- - - 1000 W/m²



WhisperSolar Series

	195 Wp	330 Wp
Article Number	60110402	60110439
TECHNICAL SPECIFICATIONS		
Model name	WhisperSolar M	WhisperSolar L
Power rating	195 Wp	330 Wp
Rated current IMPP	9.4 A	9.6 A
Rated voltage VMPP	19.7 VDC	34.4 VDC
Open circuit voltage VOC	23.9 VDC	41.0 VDC
Cell Type	Monocrystalline	Monocrystalline
Temperature range	-40 up to 85°C	-40 up to 85°C
Dimensions (W x D x H) in mm	1482 x 676 x 35	1660 x 1000 x 35
Weight	15 kg / 33.1 lb	18.9 kg / 40.1 lb
Connection	Box on panel	Box on panel
Cable and connectors	Solar cable 4 mm, length 1000 mm, PV4 connectors	
Life span	> 20 years	> 20 years
Voltage regulator (optional)	Suntrack MPPT	Suntrack MPPT

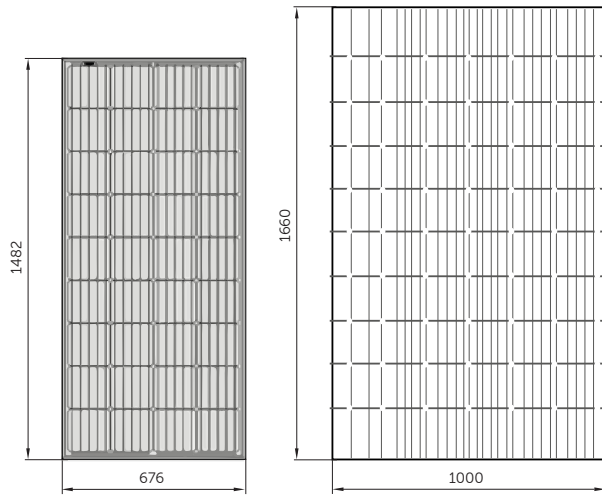

WhisperSolar
195 Wp
Art. Nr. 60110402

WhisperSolar
330 Wp
Art. Nr. 60110439

Installation Parts

- Cable sets from battery to panel
- Mounting kit
- Fixing brackets for mounting on roof



CORNER SUPPORTS
SET OF 4

Art. Nr. 60111422



BRACKET ASSEMBLY
ADHESIVE

Art. Nr. 60111440



BRACKET ASSEMBLY
ACTIVATOR

Art. Nr. 60111441



BRACKET SUPPORTS
680 MM | SET OF 2 PCS

Art. Nr. 60111421



SOLAR CABLE ENTRY

Art. Nr. 60111425

Solar Installation



SOLAR PV
CABLE | 4 MM²

Art. Nr. 60110475



SOLAR PV
CONNECTOR MALE

Art. Nr. 60110415



SOLAR PV
CONNECTOR FEMALE

Art. Nr. 60110416



SOLAR PV Y-CONNECTOR
MALE-MALE-FEMALE

Art. Nr. 60110417



SOLAR PV Y-CONNECTOR
MALE-FEMALE-FEMALE

Art. Nr. 60110418

PWM-Suntrack

Solar Charge Controller

The Suntrack PWM controllers are our step-in models suitable to be installed in solar systems with limited power (trickle charge application)

PWM stands for Pulse Width Modulation technology, based on high efficient transistors. The "raw" energy generated by the sun is converted to a smooth single step charge voltage, allowing the battery to charge fully without overcharging.

This basic controller is available for 10 and 20 A output current. Charge voltage can be set according to the battery chemistry applied.



Connections of the PWM

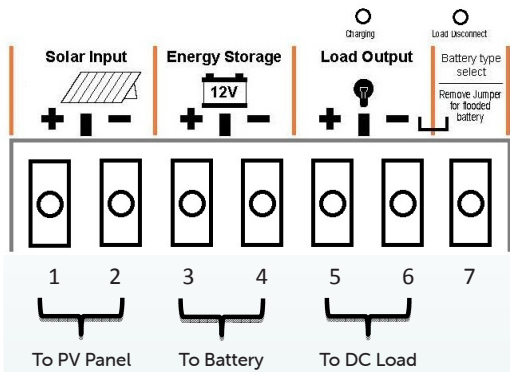

Suntrack PWM Series

	12 VDC 10 A	12 VDC 20 A
Article Number	60110409	60110411
DC INPUT		
Maximum PV voltage	26 VDC	26 VDC
Maximum PV current	10 A	20 A
Voltage across PV & Battery	< 0.15 VDC	< 0.15 VDC
DC OUTPUT BATTERY		
Battery rating	12 VDC	12 VDC
Battery type	AGM, GEL and Lead acid	AGM, GEL and Lead acid
Maximum charge current	10 A	20 A
Charge voltage range	14.2 - 14.6 VDC	14.2 - 14.6 VDC
Float voltage range	13.4 - 13.8 VDC	13.4 - 13.8 VDC
Parasitic current	< 10 mA	< 15 mA
DC OUTPUT (LOAD)		
Load current (continuous)	10 A	20 A
PROTECTION		
PV Reverse Polarity	Protected	Protected
Battery overcharge	Yes	Yes
Load over-discharge voltage	< 11.5 VDC	< 11.5 VDC
Load reconnected voltage	12.6 VDC	12.6 VDC
Built-in temperature sensor	Yes, temperature compensation on charging voltage	
INDICATOR		
Indicators	Charging/Load Disconnect LED Indicator	
ENCLOSURE		
Input/Output connection	Heavy duty terminals	Heavy duty terminals
Dimensions (W x D x H) in mm	100 x 33 x 100	100 x 33 x 100
Weight	0.2 kg / 0.4 lb	0.2 kg / 0.4 lb

Suntrack 50

MPPT Solar Charge Controller

The WhisperPower Suntrack 50 MPPT Solar Charge controller is connecting solar panels (PV) to a 12, 24, 36 or 48 VDC battery.

The advanced MPPT (Stand for Maximum Power Point Tracking) technology applied ensures a fast and complete charge, even under cloudy and fluctuating weather circumstances. The Suntrack 50 comes with a monitoring APP and bluetooth connection.



EcoSolar App

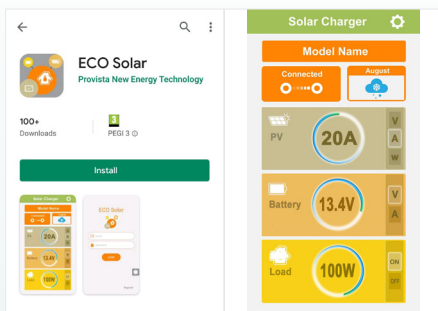

Installation Example

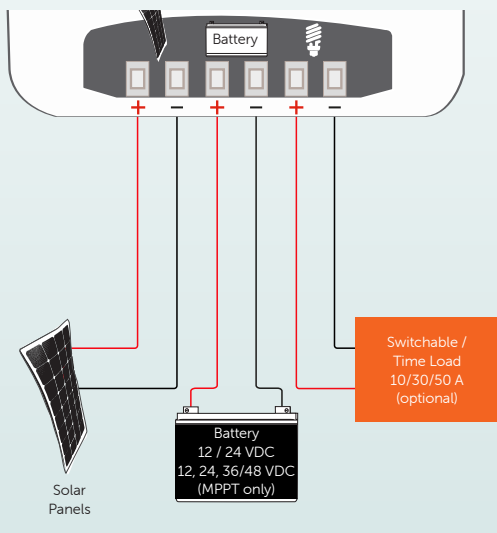

Suntrack 50

12- 48 VDC | 50 A

Article Number	60111436
PV INPUT	
PV maximum open circuit voltage (VDC)	135 VDC
MPPT voltage	16 - 108 VDC
Maximum PV input power	12 VDC Battery 700 W 24 / 48 VDC Battery 1400 W
Maximum MPPT current	12 / 24 VDC / 50 A 36 VDC / 35 A 48 VDC / 25 A
DC OUTPUT	
Battery voltage	12 / 24 / 36 / 48 VDC
Battery capacity	≥ 50 Ah
Output current	50 A maximum
Constant voltage charging voltage	STD: 14.4 VDC 43.2 VDC / 5 7.6 VDC LI: 14.5 VDC AGM: 14.6 VDC / 29.2 VDC / 43.8 VDC / 58.4 VDC
LOAD OUTPUT	
Output voltage	12 / 24 / 36 / 48 VDC
Output current	50 A
Output protection current	55 A
USB OUTPUT	
Output voltage	5 VDC
Maximum output current	3.4 A maximum
Standby current	Battery input 12 VDC
Solar charger	< 60 mA
Solar charger + Wifi module	< 160 mA
PROTECTIVE FUNCTION	
PV/Battery input high/low voltage protection	Yes
PV/Battery reverse connection protection	Yes
Load overcurrent/short circuit protection	Yes
Temp protection	Yes (90°C)
Operation Temperature	-10 up to 40°C
DIMENSIONS	
Dimensions (W x D x H) in mm	238 x 73 x 177
Weight	2.3 kg / 5.1 lb

Suntrack Duo

12 VDC | 50 A - 24 VDC | 30 A

With our state of the art, easy to use design, this product will offer you reliable service for providing a multi-stage, multi-input battery charger to charge the different types of batteries you have installed in either your home, boat, RV, caravan, 4WD or commercial vehicle. The unit can also be used as a charger/booster between the propulsion engine's alternator/ starter battery and the service battery by utilizing the 2nd DC input.



Suntrack Duo Series

	12 VDC 50 A	24 VDC 30 A
--	---------------	---------------

Article Number	60111430	60111431
OUTPUT RATING		
Output Current (Maximum)	50 A	30 A
Output Voltage	12 VDC Nominal	24 VDC Nominal
Output Power	775 W	930 W
CHARGER DC OUTPUT- HOUSE BATTERY (CH1)		
Selectable Battery Type	AGM, GEL, Lead acid, Lithium	
Bulk /Float Voltage Range		
GEL:	14.4 / 13.7 VDC	28.8 / 27.4 VDC
AGM:	14.6 / 13.6 VDC	29.2 / 27.2 VDC
Lead acid:	14.4 / 13.3 VDC	28.8 / 26.6 VDC
Lithium:	13.9 – 14.6 VDC	27.8 – 29.2 VDC
Program:	13.8 – 14.8 VDC	27.6 – 29.6 VDC
Restart Voltage (GEL, AGM, Lead acid, Program)	12.5 VDC	25 VDC
Restart Voltage (Lithium)	13.3 VDC	26.6 VDC
Charger Current (User Selectable)	5 - 50 A (5 A steps)	5 / 10 / 20 / 30 A
Equalized Voltage (Flooded Battery only)	15.5 VDC	31 VDC
Equalized Charging Current	10 % of Bulk Current Setting	
Charging Control	AGM, GEL, Lead acid, Program Mode: Two or Three Stages Lithium: three stages only	
DC Output Bank	Single	Single
Current draw from CH1 with unit ON	< 70 mA	< 70 mA
Current draw from CH1 with Unit OFF	< 200 µA	< 200 µA
Battery Temperature Setting	Low / Normal / High (automatically overridden with optional BTS)	
Efficiency	95 %	95 %
Minimum Operating Voltage	8 VDC	16 VDC
DC INPUT - SOLAR ARRAY/PANELS (CH2- SOLAR)		
Input Voltage	14.5 – 50 VDC	14.5 – 50 VDC
Maximum Solar Input Current	30 A	30 A
Maximum Solar Input Power:	12 VDC Panel: 600 W 24 VDC Panel: 800 W	600 W 1080 W
DC INPUT – ALTERNATOR/ START BATTERY (CH3- ALTERNATOR/START)		
Input Voltage	10.5 – 16 VDC / 21 – 32 VDC	
Maximum Input Current (as per maximum setting)	50 A	50 A
WEIGHT AND DIMENSIONS		
Dimensions (W x D x H) in mm	172 x 74 x 242	172 x 74 x 242
Weight	1.9 kg / 4.1 lb	1.9 kg / 4.1 lb

SunTrack Duo Diagram

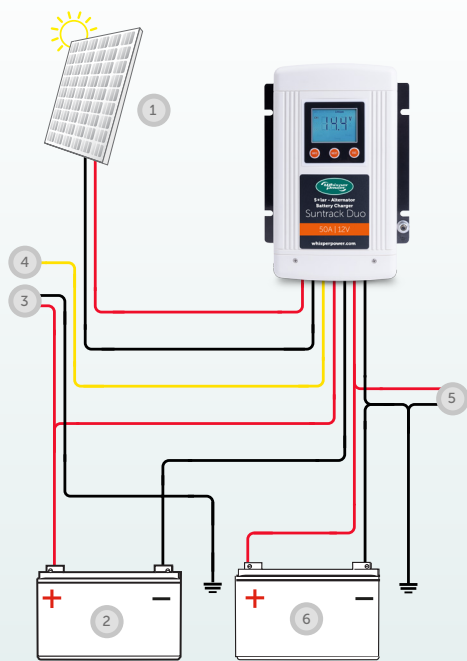

1. Solar panel
2. Starter Battery
3. Engine Alternator
4. Ignition Control (D+)
5. DC Output
6. Service Battery



Suntrack Pro

MPPT Solar Charge Controller



Suntrack Pro Series

Article Number	12-48 VDC 40 A			12-48 VDC 65 A			12-48 VDC 80 A ^{*)}		
60110423	60110423			60110420			60110421		
ELECTRICAL CHARACTERISTICS PV ARRAY SIDE									
Nominal battery voltage	12 VDC	24 VDC	48 VDC	12 VDC	24 VDC	48 VDC	12 VDC	24 VDC	48 VDC
Maximum Solar power 12 VDC	625 W	1250 W	2500 W	1000 W	2000 W	4000 W	1250 W	2500 W	5000 W
Maximum Solar power 24 VDC	80 VDC	150 VDC	150 VDC	80 VDC	150 VDC	150 VDC	80 VDC	150 VDC	150 VDC
Maximum Solar operating voltage	75 VDC	145 VDC	145 VDC	75 VDC	145 VDC	145 VDC	75 VDC	145 VDC	145 VDC
Minimum Solar operating circuit voltage	above battery voltage			above battery voltage			above battery voltage		
ELECTRICAL CHARACTERISTICS BATTERY SIDE									
Maximum Output Current	40 A			65 A			80 A		
Nominal Battery Voltage automatic/manual set	12, 24 or 48 VDC			12, 24 or 48 VDC			12, 24 or 48 VDC		
Operating voltage range	Above battery voltage, minimum 7 VDC			Above battery voltage, minimum 7 VDC			Above battery voltage, minimum 7 VDC		
PERFORMANCE OF THE DEVICE									
Power Conversion efficiency (in a 48 VDC typical-system)	> 98 %			> 98 %			> 98 %		
Maximum Stand-By Self-Consumption (48 VDC)	25 mA > 1.2 W			25 mA > 1.2 W			25 mA > 1.2 W		
Maximum Stand-By Self-Consumption (24 VDC)	30 mA > 0.8 W			30 mA > 0.8 W			30 mA > 0.8 W		
Maximum Stand-By Self-Consumption (12 VDC)	35 mA > 0.5 W			35 mA > 0.5 W			35 mA > 0.5 W		
Charging stages	4 stages: Bulk, Absorption, Float, Equalization								
Battery temperature compensation	-3 mV / °C / cell (25°C ref) default value adjustable -8 to 0 mV / °C								
ELECTRONIC PROTECTIONS									
PV reverse polarity	up to -150 VDC			up to -150 VDC			up to -150 VDC		
Battery reverse polarity	up to -150 VDC			up to -150 VDC			up to -150 VDC		
Battery overvoltage	up to -150 VDC			up to -150 VDC			up to -150 VDC		
Over temperature	Protected			Protected			Protected		
Reverse current at night	Prevented by relays			Prevented by relays			Prevented by relays		
ENVIRONMENT									
Operating Ambient Temperature Range	-20 up to 55°C			-20 up to 55°C			-20 up to 55°C		
Humidity	100 %			100 %			100 %		
Ingress Protection of enclosures	IP54, IEC/EN 60529:2001			IP54, IEC/EN 60529:2001			IP54, IEC/EN 60529:2001		
Mounting location	interior			interior			interior		
GENERAL DATA									
Warranty	5 years			5 years			5 years		
Weight	3.8 kg / 8.4 lb			5.2 kg / 11.5 lb			5.5 kg / 12.1 lb		
Dimensions (W x D x H) in mm	220 x 120 x 310			220 x 120 x 310			220 x 120 x 350		
Parallel operation (separated PV arrays)	yes			yes			yes		
Maximum wire size	35 mm ²			35 mm ²			35 mm ²		
Glands	M20 x 1.5			M20 x 1.5			M20 x 1.5		
COMMUNICATIONS									
Network Cabling	communication bus			communication bus			communication bus		
Menu languages	English/French/German/Spanish			English/French/German/Spanish			English/French/German/Spanish		
CONFORMITY									
CE compliant	EMC 2004/108/CE LV 2006/95/CE RoHS 2002/95/CE								
Safety	IEC/EN 62109-1:2010								
EMC (Electro Magnetic Compatibility)	IEC/EN 61000-6-3:2011 IEC/EN 61000-6-1:2005								

^{*)} Also available as WP Suntrack, 600 VDC, 3.5 kW or 600 VDC, 7 kW



SUNTRACK PRO

WPC-CAN to CAN interface required as interface to WhisperConnect, for being compatible with WhisperTouch panels

CAN TO CAN

WPC
CAN to CAN Interface
Art. Nr. 60201108

WHISPERTOUCH

Art. Nr. 40280105 - 5 inch
Art. Nr. 40280101 - 7 inch
Art. Nr. 40280102 - 10 inch

Using the car / vehicle engine as a generator

DC BeltPower



The propulsion engine of a sailing, motor yacht or vehicle, is in general, equipped with an average sized alternator designed to charge the starter battery. These type of alternators are not powerful enough to charge the service battery. Furthermore, the charging voltage of the alternator is regulated to maintenance level which is not really conducive to fully and quickly charging an onboard battery. This imitation is solved with a WhisperPower BeltPower alternator. We recommend installing the DC BeltPower as a second alternator with the primary function being to charge the onboard battery, or even multiple battery banks via our WBI battery Isolator.

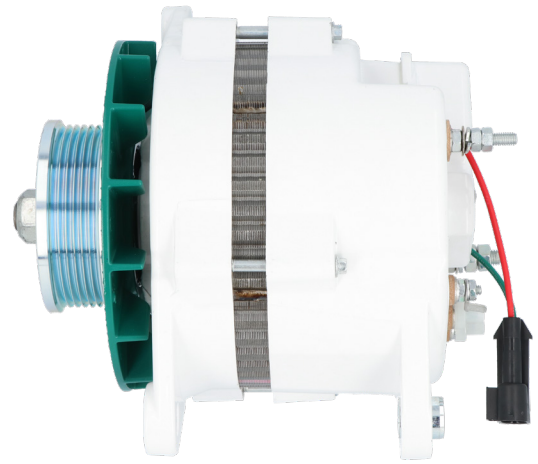

DC Beltpower
12 VDC | 90 A - Art. Nr. 60212091
24 VDC | 75 A - Art. Nr. 60224076
24 VDC | 110 A - Art. Nr. 60224111

Features

- Heavy duty 12 / 24 VDC alternator
- Charge current 75 - 110 Amps
- High charge current even at low rpm
- ACR 3-step charge system ensuring fast and complete battery charge
- Automatic charge voltage adjustment to ambient temperature via sensor on battery
- Complete Plug and Play
- Brackets available to mount alternator (not included, advice on request)
- Different pulleys available



Benefits

- On average, engine doesn't need to run for longer than an hour to charge batteries
- The ACR voltage regulator ensures batteries are 100 % charged
- Thanks to a special way of winding the alternator, there is a high charge current even at low engine speeds
- The standard 12 / 24 VDC alternator can remain in place no need to alter the standard engine configuration
- Inverters up to 3 kW can be used in combination with the DC BeltPower (advice on request)
- A smart WhisperPower WBI battery Isolator can be used to charge up to 3 individual batteries
- Suitable for every engine type

Included



Temp sensor
6 meter cable
Art. Nr. 60201202



Automatic Charge Regulator
12 VDC - Art. Nr. 60115100
24 VDC - Art. Nr. 60115200



Cable harness



DC BeltPower Series

	12 VDC 90 A	24 VDC 75 A	24 VDC 110 A
Article Number	60212091	60224076	60224111
Enclosure type	A	B	B
Charge current	90 A	75 A	110 A
Alpha Pro charge regulator	standard	standard	standard
Charge voltage absorption	14.25 VDC	28.5 VDC	28.5 VDC
Charge voltage float	13.25 VDC	26.5 VDC	26.5 VDC
Cable length regulator / alternator	1.5 metre, oil resistant marine connection cable included as standard		
Diameter double pulley	ø 73 mm	ø 88 mm	ø 88 mm
Belt section	2xA	2xA	2xA
Earthed	Yes	Yes	Yes
Turn directions	2	2	2
Weight	5.5 kg / 12.1 lb	10.1 kg / 22.3 lb	10.1 kg / 22.3 lb
Voltage regulation	WP ACR voltage regulator included as standard with all models		



DC BeltPower is available with the following pulleys

ART. NR.	PULLEY	SUITABLE FOR
60212001	Pulley Double V 5/8" 73.6 mm	For 12 VDC-90 A Alternator
60212006	Pulley Flat belt 7/8" 89 mm	For 12 VDC-130 A; 12 VDC-160 A; 24 VDC-75 A; 24 VDC-110 A; 24 VDC-150 A Alternator
60212002	Pulley Flat belt 5/8" 73.6 mm	For 12 VDC-90 A Alternator (optional)
60212005	Pulley Double V 7/8" 89 mm	For 12 VDC-130 A; 12 VDC-160 A; 24 VDC-75 A; 24 VDC-110 A; 24 VDC-150 A Alternator (optional)

Automatic Charge Regulator Series

	ACR 12 VDC	ACR 24 VDC
Article Number	60115100	60115200
GENERAL		
Nominal operation voltage	12 VDC	24 VDC
Temperature sensor	Yes, cable length 6 m	Yes, cable length 6 m
Cable harness	Yes, length 1.5 m	Yes, length 1.5 m
Connection plug regulator/alternator	WhisperPower Alternator	WhisperPower Alternator
Alternator type	WhisperPower, low voltage, brush type	WhisperPower, low voltage, brush type
ELECTRICAL		
Charge voltage - Absorption	14.25 VDC	28.50 VDC
Charge voltage - Float	13.25 VDC	26.50 VDC
Absorption Voltage range	13 - 15 VDC	27 - 31 VDC
Float Voltage range	13 - 13.9 VDC	26 - 27.8 VDC
Absorption time	0 up to 4.5 h	0 up to 4.5 h
Temperature Compensation	-30 mV / °C	-60 mV / °C
Rev counter input	Prepared	Prepared
Operation Temperature	-20 up to 80°C	-20 up to 80°C
SETTINGS/READ OUT		
Voltage settings	By trimmers on device	By trimmers on device
Time settings	By trimmers on device	By trimmers on device
Status read-out	LED's	LED's
COMMUNICATION		
Communication bus	WhisperConnect prepared	WhisperConnect prepared
ELECTRICAL		
Dimensions (W x D x H) in mm	117 x 27 x 120	117 x 27 x 120
Dimensions (W x D x H) in inches	4.60 x 4.72 x 1.05	4.60 x 4.72 x 1.05
Weight	0.4 kg	0.4 kg
Packaging dimensions (W x D x H) in mm	330 x 65 x 230	330 x 65 x 230
Protection Degree	IP65	IP65

Battery charging is accomplished in three automatic stages: BULK, ABSORPTION and FLOAT. Simple, automatic operation is made possible by the microprocessor which is the brain of the WP-ACR.

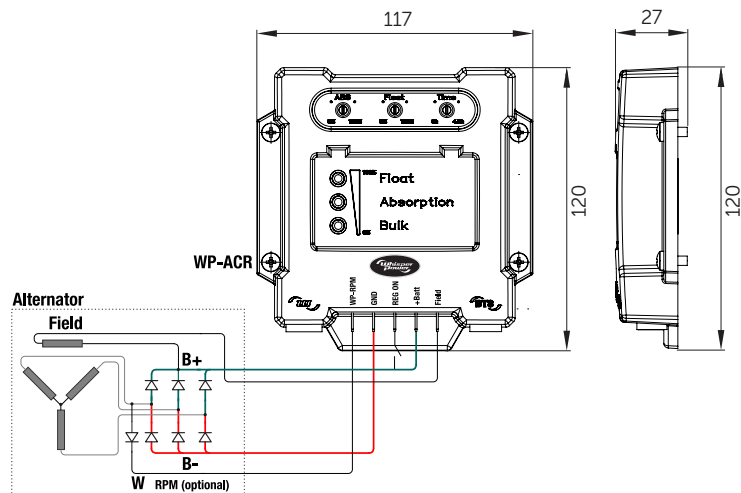
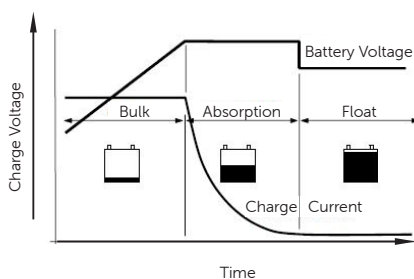

230 VAC directly from the engine

AC BeltPower



If space restrictions make it difficult to install a WhisperPower generator but 230 VAC / 50 Hz AC power is needed, then our AC BeltPower might be the solution. Both a 3.5 kW and a 5 kW version of this 'engine driven' generator are available. The system consists of a compact alternator and inverter system which convert the alternator power in to pure 230 VAC 50 Hz sine wave power. This can be used to operate small air conditioning units, tools, pumps etc. For practicality, why not also install the WPC inverter charger as an extension of the AC BeltPower system to charge the auxiliary battery and provide silent power after the engine has been switched off!

Features

- 3.5 kW and 5 kW models
- Extremely compact solution
- Alternator and inverter connected via Plug and Play cable harness
- Pure sine wave power output with high peak power
- Sufficient output even at low rpm
- WPC PowerCentre can run in parallel with AC BeltPower to provide even more powerful output
- Seamless switching from WPC inverter to AC BeltPower and vice versa
- Mounting brackets available subject to engine type. Ask your WhisperPower installer or engine supplier for more details

Benefits

- AC BeltPower eliminates need for small auxiliary generator
- Extra engine not required - one engine for everything: propulsion and electricity
- Pure sine wave power to operate all AC equipment
- Can be combined with WPC Combi / battery charger inverter



Standard pulleys and pulleys to specification

If required, WhisperPower can assist by selecting the correct pulley - there is a choice of a double or multi belt.

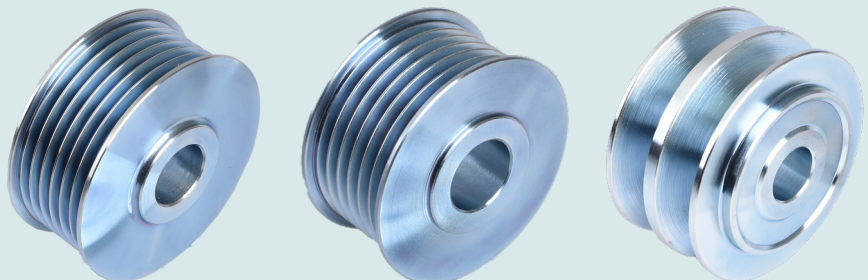

AC BeltPower Pulley Series

	POLY 6 GROOVE Ø 50 MM	POLY 6 GROOVE Ø 60 MM	DOUBLE V GROOVE 12.7 MM Ø 70 MM
Article Number	41301051	41301050	41301052



AC BeltPower Series

	3.5 kW	5 kW
Article Number	41301000	41302000
SPECIFICATIONS		
Power (continuous)	3500 W	5000 W
Max. power (continuous)	16 A	27 A
Max. starting power (320 ms)	32 A	85 A
Voltage	230 VAC	230 VAC
Frequency	50 Hz	50 Hz
INVERTER		
Dimensions (W x D x H) in mm	323 x 127 x 376 (app.)	323 x 127 x 376 (app.)
Weight Power Box	9.6 Kg / 21.2 lb	9.6 Kg / 21.2 lb
Efficiency	95 %	95 %
GENERATOR		
Weight	6.9 Kg / 15.2 lb	6.9 Kg / 15.2 lb
Dimensions (W x D x H) in mm	178 x 190 x 159	178 x 190 x 159
Voltage	200-340 VAC 3-Phase	200-340 VAC 3-Phase
Field voltage	14.4 VDC	14.4 VDC
REMOTE CONTROL PANEL		
Dimensions (W x D x H) in mm	116 x 19 x 79	116 x 19 x 79
Dimensions (W x D x H) in inches	4.6 x 0.7 x 3.1	4.6 x 0.7 x 3.1

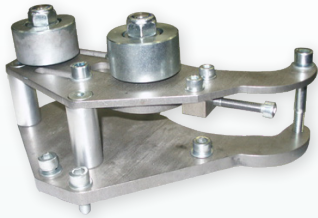

Mounting bracket kits

An essential component of the AC and DC BeltPower system is the bracket for mounting the alternator to the engine. Mounting bracket kits are available on the market for numerous engine brands, including Volvo Penta.

Shielded power cable

Art. Nr.	Length
41301020	5 m
41301021	8 m
41301022	10 m



Connection Cable

Art. Nr.	Length
41301025	5 m
41301026	10 m
50209133	15 m

Combined AC BeltPower & battery charger/inverter system

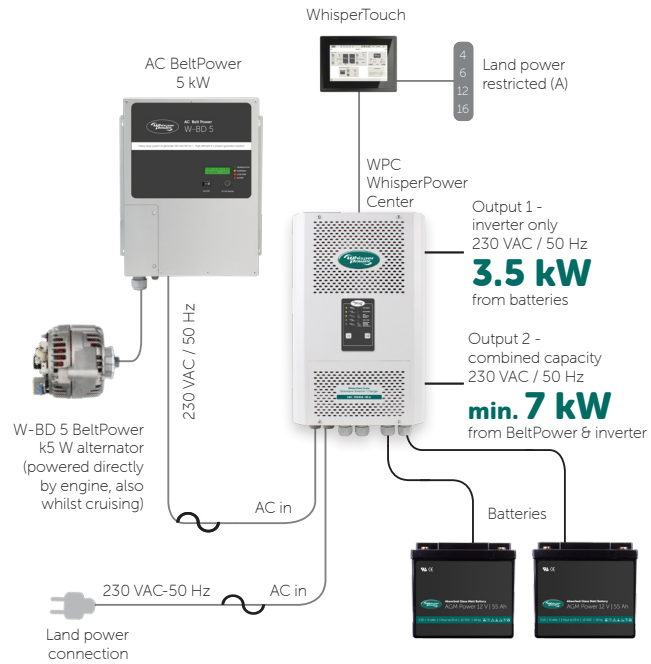

Drawing Remote Control Panel

Art. Nr. 41301030; Remote control panel for BeltPower with adjustable settings

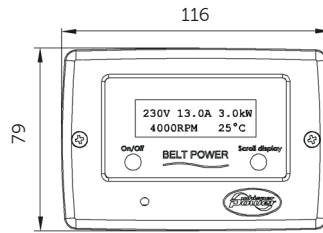

Drawing Inverter Box

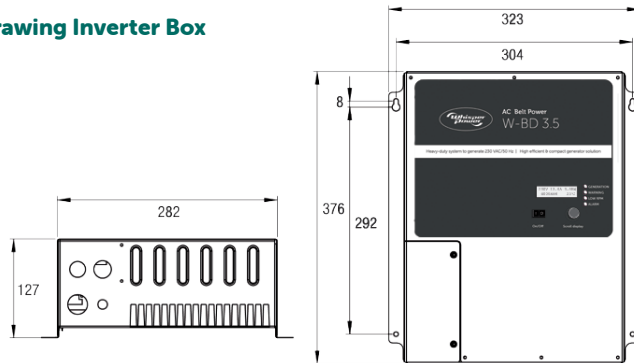

Drawing Generator

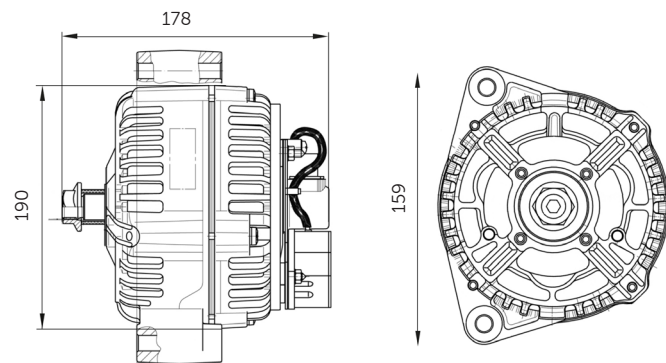

Power Storage

A-class maintenance free batteries

Batteries play an integral role in our everyday life: cell phones, laptops, tablets, navigation devices, you name it, they all require energy from a battery. In terms of yachts, commercial vessels, special vehicles or RV's, it is hard to imagine the battery as the key energy source, as the supply for all major functions such as starting the engine, powering navigation, onboard computers and operating lighting systems.



What all our batteries have in common

- Sealed and maintenance-free
- Safe - no risk of battery acid leak or gas formation
- Non-hazardous and qualifies for air freight
- Shockproof - if the battery is damaged liquid will not escape
- Designed for a large number of charge / discharge cycles
- Provided with the correct charging devices via the WhisperPower Network
- Low self-discharge - batteries can be stored for months without need to be recharged
- Little ventilation necessary in the location where the batteries are placed
- Delivered with extended system warranty
- Our warranty is valid worldwide, replacement is simple
- Only new lead used in manufacturing process

In a WhisperPower system the battery does in fact play a key role. It is the central "energy tank" which also supplies power to the inverter, or combined inverter / Genverter® / generator system. Choosing the correct battery capacity and technology is crucial for the functionality, safety and durability of these systems. We assist you in choosing the right battery for your installation. The following pages provide more information on the various types of batteries available and about the differences between each of our products.



Power Storage AGM Batteries

[Go to Page 64](#)

AGM Batteries

- The most cost effective maintenance-free, sealed batteries
- Designed for extensive electrical systems (cyclic operation)
- Can also be used to start engines
- Ideal power source for pumps, winches and other temporary loads
- Available from 55 Ah to 260 Ah, 12 VDC (24 or 48 VDC in series)



Power Storage GEL Batteries

[Go to Page 68](#)

GEL Batteries

- Heavy duty, long life, deep cycle battery
- Designed for daily charge / discharge cycles
- Can also be used to start engines
- Ideal as AC / DC inverter supply
- Suitable for slow discharge / charge and for high surge in/out
- Available from 110 Ah - 225 Ah



Power Storage

GEL Batteries 2 VDC cells
forklift / traction quality

[Go to Page 70](#)



Power Storage

Lithium Batteries

[Starting on Page 72](#)

GEL Batteries - 2 volt cells, forklift / traction quality

- Designed to last for over 10 years
- Suitable for a large number of charge cycles (1200 to 3000 depending on discharge level)
- Ideal battery for large battery banks (600 to 2100 Ah)
- Best option for intensively used heavy duty inverter(s)
- Suitable for high charge current (50 % of nominal capacity)
- 7 year warranty pro-rata

Lithium Batteries

- Lithium Iron Phosphate (LiFePO4)
- High energy density
- Up to 50% space saving in comparison to GEL/AGM
- 30 - 40 % weight saving
- Longest life span in number of cycles, approx. 5000
- Complete with Battery Management System (BMS) to maintain balance of cells
- Complete with Whisper Interface Box and DC distribution systems

Manufacturing Partners

The specifications of all WhisperPower batteries are meticulously defined by us based on the requirements of our systems. The factories manufacturing our batteries have been carefully selected and meet the following very important criteria:

- Only the best is good enough
- We only work with premium manufacturing partners
- Manufacturing processes must be of highest class and absolutely non-polluting
- Our main manufacturing partner is a NASDAQ listed company employing more than 2000 personnel and is fully ISO9001:2000 certified

Sealed Maintenance-Free Batteries

We advise against the use of lead acid batteries. These are not as safe as sealed, maintenance-free batteries due to the the risk of gas formation and the need to top up the battery with distilled water from time to time. Lead acid batteries require good ventilation. In comparison, AGM batteries (Absorbed Glass Matt) are hardly any more expensive and far easier to use. GEL batteries are, on average, 30 % more expensive due to the technology applied but this results in a longer life span.

Durable

AGM Batteries

These are the most economical, maintenance-free batteries designed for long life. WhisperPower AGM batteries are based on VRLA technology (Valve Regulated Lead Acid), meaning they require little ventilation, do not have to be positioned upright and do not require any maintenance.



Applications

- Starting main and auxiliary engines
- Powering DC appliances
- Power supply for entire DC installation
- Back-up battery for vital functions such as radios/transmitters
- Suitable for medium sized inverters

General guidelines

- Charge according to three step process (IUoUo)
- Keep battery connected to the charger even when not in use. When not in use, but disconnect the DC cables in case of extended storage periods (after fully charging)
- Connect the battery sensor, supplied with you WhisperPower battery charger, to the battery, this will adapt the charge voltage level during fluctuation temperature circumstances



Battery terminals (optional)



Adapter set M6 < 100 Ah Art. Nr. 40290097
Adapter set M8 > 100 Ah Art. Nr. 40290099



Discharge effect on battery life

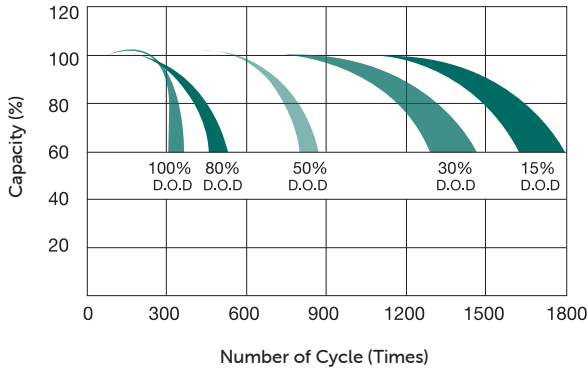

Discharge curves

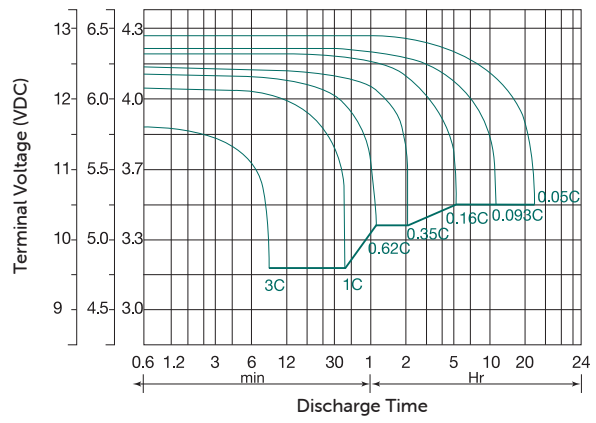

Storage effect

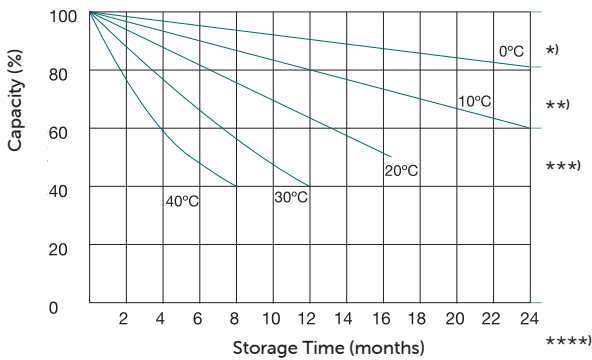

- *) Supplementary charge required (Carry out supplementary charge before use if 100% capacity is requires)
- ***) Supplementary charge required before use
This supplementary charge will help to recover the capacity and should be made as early as possible
- ****) Supplementary charge may often fail to recover the capacity.
The battery should never be left standing till this state is reached
- *****) Supplementary charge and storage guidelines



AGM Power Series



	12 VDC 55 Ah	12 VDC 80 Ah	12 VDC 100 Ah	12 VDC 145 Ah
Article Number	40290060	40290061	40290031	40290062
TECHNICAL SPECIFICATIONS				
Nominal capacity	55 Ah	80 Ah	100 Ah	145 Ah
C10* ¹ or C20	C10	C10	C10	C10
Nominal voltage	12 VDC	12 VDC	12 VDC	12 VDC
Type	Deep discharge Absorbed Glass Mat battery with potential 10 year life span on float voltage, specifically designed for intensive cyclic use. Cyclic life 30 % longer thanks to strong grid and a specific paste composition. Suitable for marine, mobile and solar energy system and as a starter battery			
Weight ± 10 %	18 kg	24 kg	30 kg	44 kg
Dimensions (W x D x H) in mm (excl. poles)	229 x 138 x 210	350 x 167 x 180	328 x 172 x 222	340 x 173 x 280
Terminal type	M6 stainless steel	M6 stainless steel	M8 stainless steel	M8 stainless steel
Number of cells	6	6	6	6
CHARGE / DISCHARGE PARAMETERS				
Constant charge voltage (IU, float)	13.60 - 13.80 VDC at 25°C	13.60 - 13.80 VDC at 25°C	13.60 - 13.80 VDC at 25°C	13.60 - 13.80 VDC at 25°C
Cyclic charge voltage (IUU, absorption)	14.25 - 14.60 VDC at 25°C	14.25 - 14.60 VDC at 25°C	14.25 - 14.60 VDC at 25°C	14.25 - 14.60 VDC at 25°C
Maximum charge current	16.5 A	24 A	30 A	43.5 A
Temperature ratio	-4 mVDC / cel / °C	-4 mVDC / cel / °C	-4 mVDC / cel / °C	-4 mVDC / cel / °C
Discharge voltage	1.75 VDC at (A) ≤ 0.2°C 1.70 VDC at 0.2°C (A) ≤ 1.0°C	1.75 VDC at (A) ≤ 0.2°C 1.70 VDC at 0.2°C (A) ≤ 1.0°C	1.75 VDC at (A) ≤ 0.2°C 1.70 VDC at 0.2°C (A) ≤ 1.0°C	1.75 VDC at (A) ≤ 0.2°C 1.70 VDC at 0.2°C (A) ≤ 1.0°C
Full discharge (100 % DOD)	1.65 VDC at (A) ≥ 1.0°C	1.65 VDC at (A) ≥ 1.0°C	1.65 VDC at (A) ≥ 1.0°C	1.65 VDC at (A) ≥ 1.0°C
NOMINAL CAPACITY AT 25°C				
	UP TO 1.75 VDC/CEL	UP TO 1.75 VDC/CEL	UP TO 1.75 VDC/CEL	UP TO 1.80 VDC/CEL
20 hours discharge	58.6 Ah	85.3 Ah	104 Ah	167 Ah
10 hours discharge	55 Ah	80 Ah	100 Ah	145 Ah
5 hours discharge	44.5 Ah	65 Ah	89 Ah	131 Ah
Peukert Coefficient	1.21 < P < 1.24	1.21 < P < 1.24	1.21 < P < 1.24	1.21 < P < 1.24
Usage at 25 A discharge	92 min.	146 min.	190 min.	305 min.
Self discharge	Less than 3 % per month at 25°C			
Storage time	AGM batteries can be stored for up to 6 months at 25°C, recommended to charge before use			
BATTERY PARAMETERS				
Inrush Current at 25°C (5 seconds)	550 A	800 A	1000 A	1450 A
Cyclic life at 80 % discharge	400	400	400	400
Internal resistance (approx.)	6 mΩ	5.5 mΩ	5 mΩ	4.5 mΩ

Dimensions

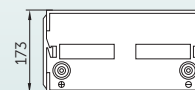
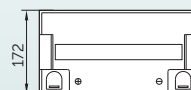
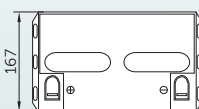
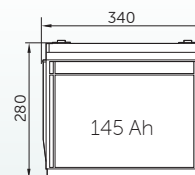
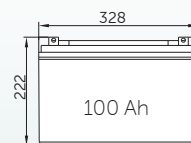
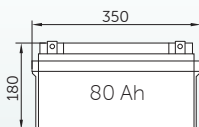
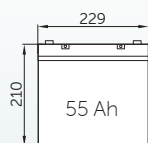



12 VDC 165 Ah	12 VDC 200 Ah	12 VDC 260 Ah
40290033	40290063	40290064
165 Ah	200 Ah	260 Ah
C20	C10	C10
12 VDC	12 VDC	12 VDC
47 kg	60 kg	74 kg
483 x 170 x 240	522 x 240 x 219	520 x 268 x 220
M8 stainless steel	M8 stainless steel	M8 stainless steel
6	6	6
13.60 - 13.80 VDC at 25°C	13.60 - 13.80 VDC at 25°C	13.60 - 13.80 VDC at 25°C
14.25 - 14.60 VDC at 25°C	14.25 - 14.60 VDC at 25°C	14.25 - 14.60 VDC at 25°C
49.5 A	60 A	78 A
-4 mVDC / cel / °C	-4 mVDC / cel / °C	-4 mVDC / cel / °C
1.75 VDC at (A) ≤ 0.2°C 1.70 VDC at 0.2°C (A) ≤ 1.0°C	1.75 VDC at (A) ≤ 0.2°C 1.70 VDC at 0.2°C (A) ≤ 1.0°C	1.75 VDC at (A) ≤ 0.2°C 1.70 VDC at 0.2°C (A) ≤ 1.0°C
1.65 VDC at (A) ≥ 1.0°C	1.65 VDC at (A) ≥ 1.0°C	1.65 VDC at (A) ≥ 1.0°C
UP TO 1.80 VDC/CEL	UP TO 1.80 VDC/CEL	UP TO 1.80 VDC/CEL
165 Ah	226 Ah	278 Ah
157 Ah	200 Ah	260 Ah
134 Ah	180 Ah	220 Ah
1.21 < P < 1.24	1.21 < P < 1.24	1.21 < P < 1.24
320 min.	455 min.	630 min.
Less than 3 % per month at 25°C	Less than 3 % per month at 25°C	Less than 3 % per month at 25°C
AGM batteries can be stored for up to 6 months at 25°C, recommended to charge before use	AGM batteries can be stored for up to 6 months at 25°C, recommended to charge before use	AGM batteries can be stored for up to 6 months at 25°C, recommended to charge before use
1650 A	2000 A	2600 A
400	400	400
3.8 mΩ	4 mΩ	3.5 mΩ

*1) C10= measured capacity at 10 % discharge per hour over 10 hours

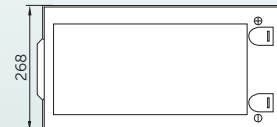
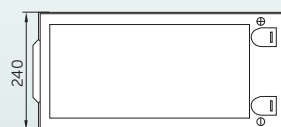
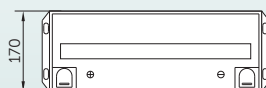
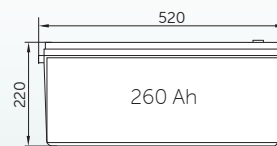
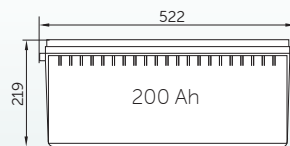
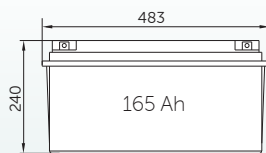

Deep cycle

GEL Batteries - 12 VDC

Our GEL batteries are the most reliable and powerful batteries available on the market. You can choose between two types: a 12 VDC battery, suitable for battery banks up to approximately 700 Ah (12 or 24 VDC) and individual 2 VDC cells, which are suitable for building into one solid battery bank 2000 Ah at 12, 24 or 48 VDC.



The difference between GEL and AGM batteries

- In GEL batteries the electrolyte is absorbed by a sort of GEL rendering the battery stronger and more robust
- GEL provide better heat dispersion (conduction) than Absorbed Glass Mat (AGM)
- GEL batteries have a longer life span (greater charge-/discharge cycle)
- 12 VDC GEL batteries are the best option for frequently used electrical systems

The difference between 2 VDC GEL cells and 12 VDC GEL batteries

- 2 VDC cells are designed for daily deep charge-/discharge cycles
- 2 VDC cells are used in various industrial applications such as material transportation
- 2 VDC cells can withstand high peak loads (from electrical motors for example) and high charge currents
- 2 VDC cells have tubular plates instead of flat plates resulting in very high power density
- 2 VDC cells go up to 2000 Ah
- No voltage drops or unequal charging when connected in series / parallel
- The cells are delivered with industrial "pre-fab" cables

For 2 VDC cells specifications, see page 70

Discharge curves

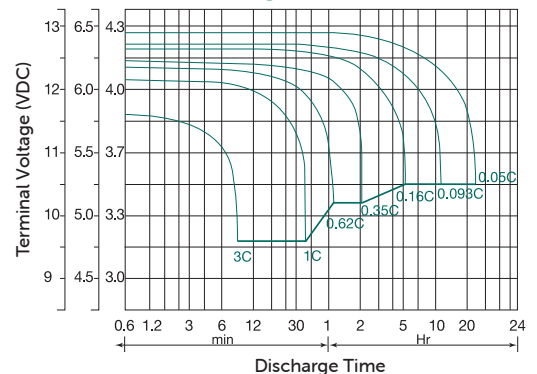

Discharge effect on battery life

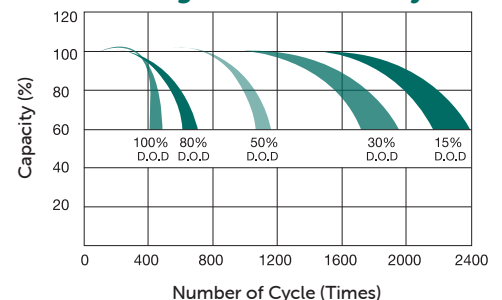

Battery terminals (optional)



Adapter set M6 < 100 Ah Art. Nr. 40290097
 Adapter set M8 > 100 Ah Art. Nr. 40290099





GEL Power Series

	12 VDC 100 Ah	12 VDC 145 Ah	12 VDC 180 Ah	12 VDC 225 Ah
Article Number	40290070	40290071	40290072	40290073
TECHNICAL SPECIFICATIONS				
Nominal capacity (C20)	100 Ah	145 Ah	180 Ah	225 Ah
Nominal voltage	12 VDC	12 VDC	12 VDC	12 VDC
Type	Deep discharge GEL battery with potential 12 year life span on float voltage. Superior design for frequent discharge cycles under extreme temperatures Strong grid construction ensures increased reliability with frequent deep discharge More than 400 cycles possible with complete discharge (100 % DOD). Extra durable cyclic performance and high recovery efficiency Ideal for marine, mobile and solar energy systems as well as intensively used emergency / back up energy systems			
Weight $\pm 10\%$	30 kg / 66.1 lb	44 kg / 97 lb	53 kg / 116.8 lb	65 kg / 143.3 lb
Dimensions (W x D x H) in mm (excl. poles)	328 x 172 x 222	340 x 173 x 280	530 x 209 x 214	522 x 240 x 219
Terminal type	M8 stainless steel	M8 stainless steel	M8 stainless steel	M8 stainless steel
Number of cells	6	6	6	6
CHARGE / DISCHARGE PARAMETERS				
Constant charge voltage (IU, float)	13.60 - 13.80 VDC at 25°C	13.60 - 13.80 VDC at 25°C	13.60 - 13.80 VDC at 25°C	13.60 - 13.80 VDC at 25°C
Cyclic charge voltage (IUU, absorption)	14.25 - 14.60 VDC at 25°C	14.25 - 14.60 VDC at 25°C	14.25 - 14.60 VDC at 25°C	14.25 - 14.60 VDC at 25°C
Maximum charge current	20 A	29 A	36 A	45 A
Temperature ratio	-4 mVDC / cel / °C	-4 mVDC / cel / °C	-4 mVDC / cel / °C	-4 mVDC / cel / °C
Discharge voltage	1.75 VDC at (A) $\leq 0.2^\circ\text{C}$ 1.70 VDC at 0.2°C (A) $\leq 1.0^\circ\text{C}$	1.75 VDC at (A) $\leq 0.2^\circ\text{C}$ 1.70 VDC at 0.2°C (A) $\leq 1.0^\circ\text{C}$	1.75 VDC at (A) $\leq 0.2^\circ\text{C}$ 1.70 VDC at 0.2°C (A) $\leq 1.0^\circ\text{C}$	1.75 VDC at (A) $\leq 0.2^\circ\text{C}$ 1.70 VDC at 0.2°C (A) $\leq 1.0^\circ\text{C}$
Full discharge (100 % DOD)	1.65 VDC at (A) $\geq 1.0^\circ\text{C}$	1.65 VDC at (A) $\geq 1.0^\circ\text{C}$	1.65 VDC at (A) $\geq 1.0^\circ\text{C}$	1.65 VDC at (A) $\geq 1.0^\circ\text{C}$
NOMINAL CAPACITY AT 25°C				
	UP TO 1.75 VDC/CEL	UP TO 1.75 VDC/CEL	UP TO 1.80 VDC/CEL	UP TO 1.80 VDC/CEL
20 hours discharge	100 Ah	145 Ah	180 Ah	225 Ah
10 hours discharge	95 Ah	136 Ah	169 Ah	209 Ah
5 hours discharge	84 Ah	117 Ah	146 Ah	181 Ah
Peukeurt Coefficient	1.21 < P < 1.24	1.21 < P < 1.24	1.21 < P < 1.24	1.21 < P < 1.24
Usage at 25 A discharge	165 min.	261 min.	341 min.	450 min.
Self discharge	Less than 3 % per month at 25°C			
Storage time	GEL batteries can be stored for up to 6 months at 25°C, recommended to charge before use			
BATTERY PARAMETERS				
Inrush Current at 25°C (5 seconds)	1000 A	1450 A	1800 A	2250 A
Cyclic life at 80 % discharge	600	600	600	600
Internal resistance (approx.)	7.5 m Ω	5 m Ω	6 m Ω	4 m Ω

Dimensions

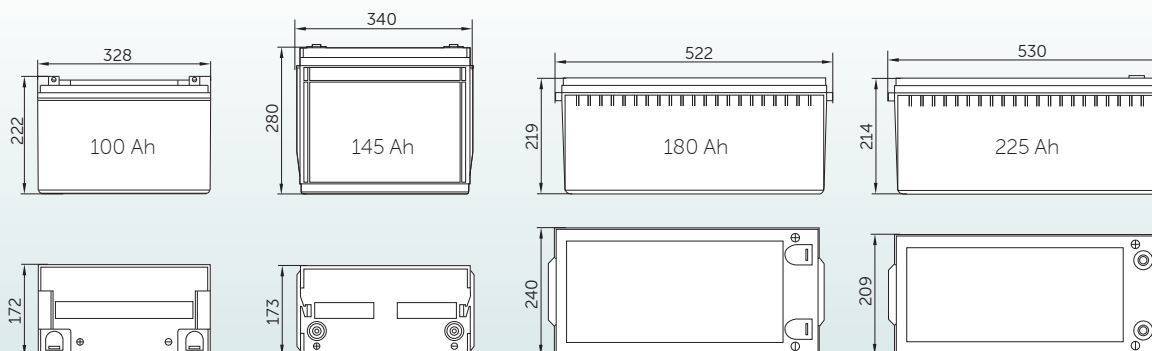

Storage effect

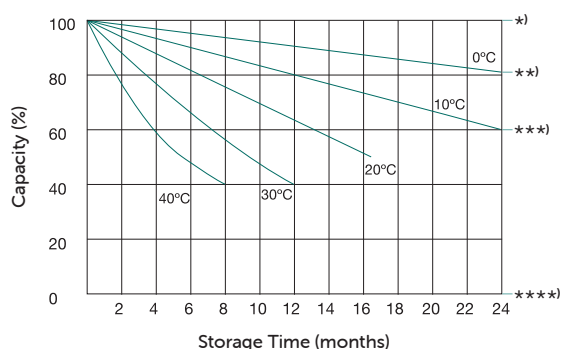

- * Supplementary charge required
(Carry out supplementary charge before use if 100% capacity is required)
- ** Supplementary charge required before use.
This supplementary charge will help to recover the capacity and should be made as early as possible
- *** Supplementary charge may often fail to recover the capacity.
The battery should never be left standing till this state is reached
- **** Supplementary charge and storage guidelines



Multi cycle 2 Volt Cells

Whilst vertical installation is recommended, 2 VDC GEL cells can be installed up to 30 degree angle. Horizontal installation can be ordered on request. Cables to connect the individual 2 VDC cells together are supplied as standard.

Recommended Use

- For both 2 VDC and 12 VDC GEL batteries:
- Charge according to three step process (IUoUo) (see page 6 - 15)
- Keep battery connected to the charger even when not in use
- Use the temperature sensor to monitor the temperature of the battery
- Use alternator only on 'float voltage'
- Fit with ACR regulator as alternator will charge the battery faster and to 100%

GEL batteries - 2 VDC Cells - forklift truck / traction quality

- Designed to last for over 10 years
- Suitable for high charge current (50 % of nominal capacity)
- Ideal battery for large battery banks (600 to 8000 Ah)
- Best option for intensively used heavy duty inverter(s)
- Suitable for a large number of charge cycles (1200 to 3000 depending on discharge level)
- 7 year warranty (restricted to cycles)



▶ Ready to use, link cables

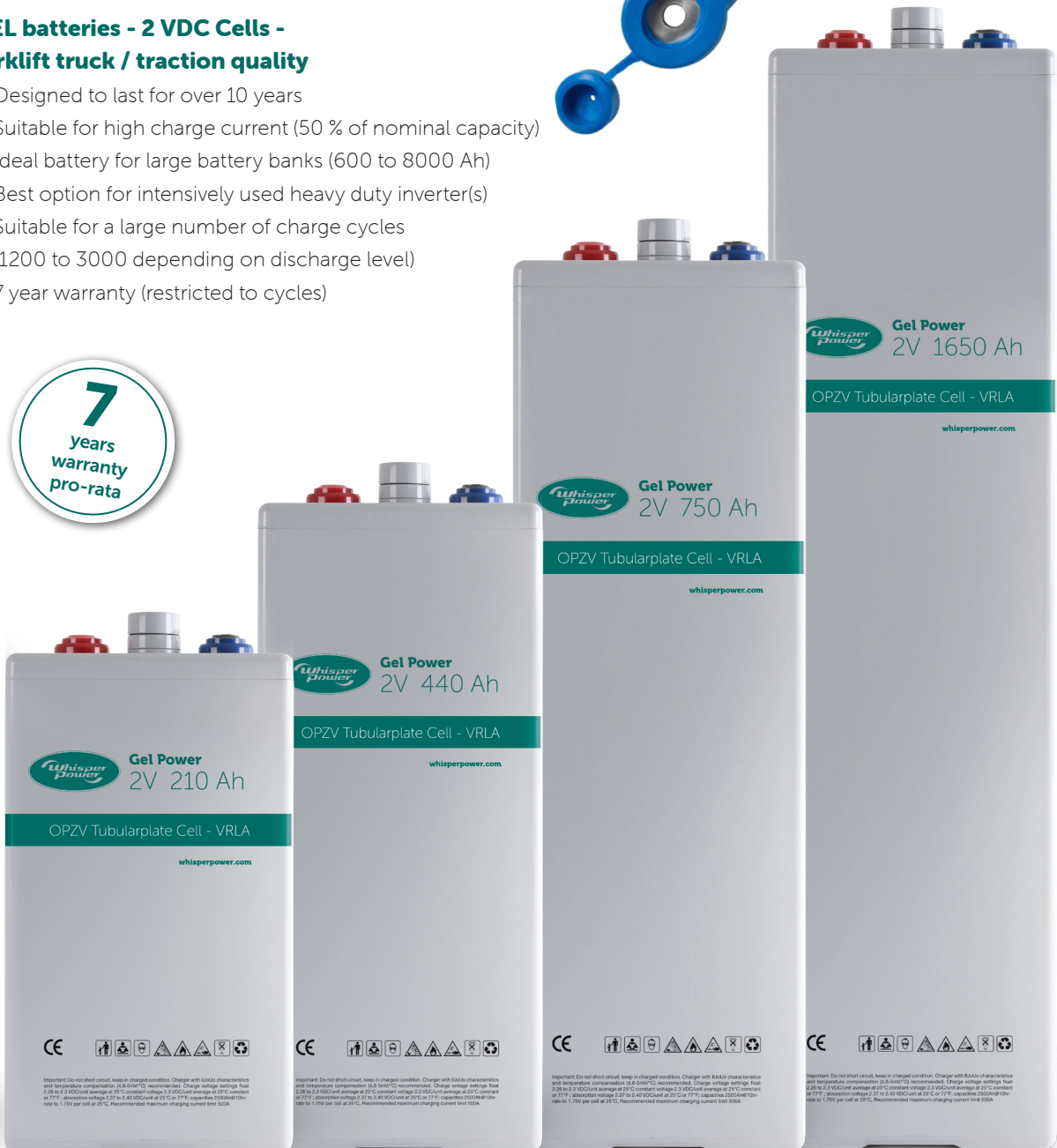

Important: Do not short circuit, keep in charged condition. Charge with suitable characteristics and temperature compensation (0.8-0.9V/°C) recommended. Charge voltage settings float 2.28 to 2.30V/cell average at 25°C constant voltage 2.25V/cell average at 25°C constant or 77°F absorption voltage 2.37 to 2.43V/cell at 25°C or 77°F respectively 2500mAh (10hr) rate to 1.70V per cell at 25°C. Recommended maximum charging current limit 0.05A.



Important: Do not short circuit, keep in charged condition. Charge with suitable characteristics and temperature compensation (0.8-0.9V/°C) recommended. Charge voltage settings float 2.28 to 2.30V/cell average at 25°C constant voltage 2.25V/cell average at 25°C constant or 77°F absorption voltage 2.37 to 2.43V/cell at 25°C or 77°F respectively 2500mAh (10hr) rate to 1.70V per cell at 25°C. Recommended maximum charging current limit 0.05A.

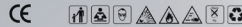

Important: Do not short circuit, keep in charged condition. Charge with suitable characteristics and temperature compensation (0.8-0.9V/°C) recommended. Charge voltage settings float 2.28 to 2.30V/cell average at 25°C constant voltage 2.25V/cell average at 25°C constant or 77°F absorption voltage 2.37 to 2.43V/cell at 25°C or 77°F respectively 2500mAh (10hr) rate to 1.70V per cell at 25°C. Recommended maximum charging current limit 0.05A.

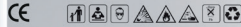

Important: Do not short circuit, keep in charged condition. Charge with suitable characteristics and temperature compensation (0.8-0.9V/°C) recommended. Charge voltage settings float 2.28 to 2.30V/cell average at 25°C constant voltage 2.25V/cell average at 25°C constant or 77°F absorption voltage 2.37 to 2.43V/cell at 25°C or 77°F respectively 2500mAh (10hr) rate to 1.70V per cell at 25°C. Recommended maximum charging current limit 0.05A.



GEL Power 2 VDC Series

	2 VDC 210 Ah	2 VDC 440 Ah	2 VDC 525 Ah	2 VDC 750 Ah	2 VDC GEL 1000 Ah	2 VDC 1250 Ah	2 VDC 1500 Ah	2 VDC 1650 Ah
--	-----------------	-----------------	-----------------	-----------------	----------------------	------------------	------------------	------------------

Article Number	40290035	40290037	40290038	40290040 *)	40290041 *)	40290042 *)	40290043	40290044
----------------	----------	----------	----------	-------------	-------------	-------------	----------	----------

TECHNICAL SPECIFICATIONS

Nominal capacity (C10, cel 1.80 V, 20°C)	210 Ah	440 Ah	525 Ah	750 Ah	1000 Ah	1250 Ah	1500 Ah	1650 Ah
--	--------	--------	--------	--------	---------	---------	---------	---------

Nominal voltage	2 VDC	2 VDC	2 VDC	2 VDC	2 VDC	2 VDC	2 VDC	2 VDC
-----------------	-------	-------	-------	-------	-------	-------	-------	-------

Type WhisperPower OPzV valve regulated batteries are ideally suited for applications with extended deep charge / discharge cycles. They are fully maintenance free. WhisperPower GEL batteries are constructed using tubular plate technology, wherein the electrolyte is contained in the GEL. They are widely used in emergency / back-up power supplies, marine and mobile battery banks and UPS installations.

Weight ± 10 %	18 kg	33 kg	39 kg	50 kg	68 kg	82 kg	97 kg	120 kg
---------------	-------	-------	-------	-------	-------	-------	-------	--------

Dimensions (W x D x H) in mm (excl. poles)	206 x 145 x 390	206 x 145 x 506	206 x 166 x 506	206 x 145 x 643	210 x 191 x 644	210 x 223 x 646	210 x 275 x 645	210 x 275 x 796
--	-----------------	-----------------	-----------------	-----------------	-----------------	-----------------	-----------------	-----------------

Terminal type	2 x M8	2 x M8	2 x M8	2 x M8	4 x M8	4 x M8	4 x M8	4 x M8
---------------	--------	--------	--------	--------	--------	--------	--------	--------

CHARGE / DISCHARGE PARAMETERS

Bulk charge voltage (V/cel) at 20°C	2.42 VDC	2.42 VDC	2.42 VDC	2.42 VDC	2.42 VDC	2.42 VDC	2.42 VDC	2.42 VDC
-------------------------------------	----------	----------	----------	----------	----------	----------	----------	----------

Float voltage (V/cel) at 20°C	2.25 VDC	2.25 VDC	2.25 VDC	2.25 VDC	2.25 VDC	2.25 VDC	2.25 VDC	2.25 VDC
-------------------------------	----------	----------	----------	----------	----------	----------	----------	----------

Initial charge current (A)	80 A	150 A	200 A	240 A	320 A	400 A	480 A	600 A
----------------------------	------	-------	-------	-------	-------	-------	-------	-------

Temperature ratio	-4 mVDC / cel / °C	-4 mVDC / cel / °C	-4 mVDC / cel / °C	-4 mVDC / cel / °C	-4 mVDC / cel / °C	-4 mVDC / cel / °C	-4 mVDC / cel / °C	-4 mVDC / cel / °C
-------------------	--------------------	--------------------	--------------------	--------------------	--------------------	--------------------	--------------------	--------------------

Recommended discharge voltage for 10 hours discharge (V/cel)	1.80 VDC/cel	1.80 VDC/cel	1.80 VDC/cel	1.80 VDC/cel	1.80 VDC/cel	1.80 VDC/cel	1.80 VDC/cel	1.80 VDC/cel
--	--------------	--------------	--------------	--------------	--------------	--------------	--------------	--------------

Recommended discharge voltage for 1 hour discharge (V/cel)	1.65 VDC/cel	1.65 VDC/cel	1.65 VDC/cel	1.65 VDC/cel	1.65 VDC/cel	1.65 VDC/cel	1.65 VDC/cel	1.65 VDC/cel
--	--------------	--------------	--------------	--------------	--------------	--------------	--------------	--------------

NOMINAL CAPACITY AT 20°C	UP TO 1.80 VDC/CE	UP TO 1.80 VDC/CE	UP TO 1.80 VDC/CE	UP TO 1.80 VDC/CE	UP TO 1.80 VDC/CE	UP TO 1.80 VDC/CE	UP TO 1.80 VDC/CE	UP TO 1.80 VDC/CE
--------------------------	-------------------	-------------------	-------------------	-------------------	-------------------	-------------------	-------------------	-------------------

10 hours discharge	210 Ah	440 Ah	525 Ah	750 Ah	1000 Ah	1250 Ah	1500 Ah	1650 Ah
--------------------	--------	--------	--------	--------	---------	---------	---------	---------

5 hours discharge	180 Ah	370 Ah	450 Ah	650 Ah	865 Ah	1085 Ah	1305 Ah	1355 Ah
-------------------	--------	--------	--------	--------	--------	---------	---------	---------

1-hour discharge	88 Ah	184 Ah	220 Ah	314 Ah	489 Ah	570 Ah	629 Ah	647 Ah
------------------	-------	--------	--------	--------	--------	--------	--------	--------

Peukeurt Coefficient	1.21 < P < 1.23	1.21 < P < 1.23	1.21 < P < 1.23	1.21 < P < 1.23	1.21 < P < 1.23	1.21 < P < 1.23	1.21 < P < 1.23	1.21 < P < 1.23
----------------------	-----------------	-----------------	-----------------	-----------------	-----------------	-----------------	-----------------	-----------------

Usage at 25 A discharge	8 h	15 h	18 h	24 h	32 h	40 h	48 h	60 h
-------------------------	-----	------	------	------	------	------	------	------

Self discharge	Less than 3 % per month at 20°C							
----------------	---------------------------------	--	--	--	--	--	--	--

Storage time	OpzV batteries can be stored for up to 6 months at 20°C, recommended to charge before use							
--------------	---	--	--	--	--	--	--	--

BATTERY PARAMETERS

Cyclic life at 80 % discharge	1250	1250	1250	1250	1250	1250	1250	1250
-------------------------------	------	------	------	------	------	------	------	------

Internal resistance (approx.)	0.60 mΩ	0.42 mΩ	0.38 mΩ	0.35 mΩ	0.29 mΩ	0.24 mΩ	0.22 mΩ	0.19 mΩ
-------------------------------	---------	---------	---------	---------	---------	---------	---------	---------

*) Stock items

ART. NR.	ARTICLE
40290101	Connection strip set GEL Power 2 VDC for 12 VDC / 750 Ah *)
40290103	Connection strip set GEL Power 2 VDC for 12 VDC / 1000 Ah *)
40290105	Connection strip set GEL Power 2 VDC for 12 VDC / 1250/1500/1650 Ah *)

- 7 year warranty (pro rata)
- 3500 cycles at 50 % discharge
- Ah rating based on C10



*) For 24 VDC configuration 2 connections sets are required

Dimensions 2 Volt Cells

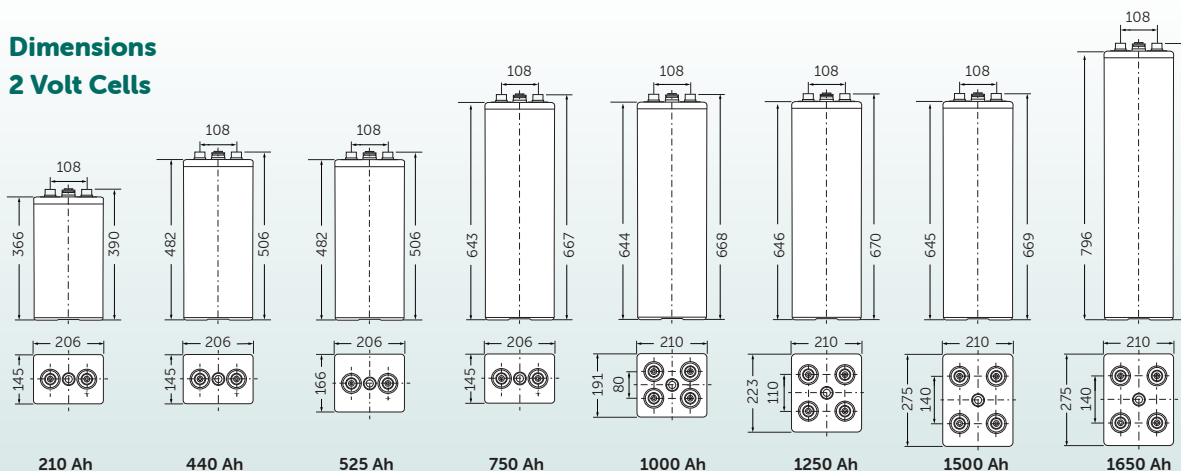

Lithium Power Basic

12 VDC | 50/100/150 Ah
24 VDC | 100 Ah

Our Lithium batteries are a great alternative to conventional batteries in all areas. By utilizing advanced chemistry and system design, WhisperPower provides enormous energy reserves. User can relax and enjoy freedom where ever they go. Lithium Power Basic battery energy management ensures lowest possible energy losses and superfast charging in combination with the safe LiFePO4 chemistry.



72



Features

- Suitable for lead acid battery replacement
- Saves up to 70 % in space and weight
- Three times the lifespan of traditional batteries
- High cycle efficiency
- Fast charging up to one hour
- High discharge rate up to 1C
- Integrated Battery Management System (BMS)
- Suitable for parallel operation up to 8 pcs
- Not suitable for serial operation
- Waterproof electronics cabinet
- Best buy price vs. cycle life
- Extremely safe LiFePO4 chemistry

Optional Accessories

- Battery Monitoring (WBM)
- DC Disconnect by Latch Relay (external discharge protection)
- Battery charging by Supreme/ Supreme Pro chargers
- Battery charging by DC alternator with smart regulator (ACR)
- Solar charging by WP solar + smart MPP regulator
- Various DC distribution devices including DC fuses



Lithium Power Basic Series



12 VDC | 50 Ah 12 VDC | 100 Ah 12 VDC | 150 Ah 24 VDC | 100 Ah

Article Number	40291201	40291202	40291203	40291205
TECHNICAL SPECIFICATIONS				
Dimensions (W x D x H) in mm	257 x 132 x 200	330 x 173 x 212	483 x 170 x 238	522 x 240 x 224
Weight	8.12 kg	12 kg	16.5 kg	29.6 kg
Terminal connection	M6	M8	M8	M8
CHARGE / DISCHARGE PARAMETERS				
Nominal voltage (VDC)	12.8 VDC	12.8 VDC	12.8 VDC	25.6 VDC
Charge cut off voltage	15.6 VDC	15.6 VDC	15.6 VDC	31.2 VDC
End charge voltage	14.6 VDC ± 0.2 VDC	14.6 VDC ± 0.2 VDC	14.6 VDC ± 0.2 VDC	29.2 VDC ± 0.2 VDC
Maximum charge current 1/C	50 A	100 A	150 A	100 A
Maximum float charge current	25 A	50 A	75 A	50 A
Minimum discharge cutt off voltage	8 VDC	8 VDC	8 VDC	16 VDC
Nominal discharge cutt off voltage	10 VDC	10 VDC	10 VDC	20 VDC
Maximum Discharge current 1/C	50 A	100 A	150 A	100 A
Pulsed discharge current (10 sec.)	60 A	120 A	250 A	100 A
Usable battery capacity at 20°C	50 Ah 640 Wh	100 Ah 1280 Wh	150 Ah 1920 Wh	100 Ah 2560 Wh
Internal Resistance	<20 mΩ	<20 mΩ	<20 mΩ	<20 mΩ
Cycle Life at 1c 100 % DOD	>2000 cycles	>2000 cycles	>2000 cycles	>2000 cycles
Months Self Discharge	<3 %	<3 %	<2 %	<3 %
Temperature range (charging)	0°C up to 45°C	0°C up to 45°C	0°C up to 45°C	0°C up to 45°C
Temperature range (discharging)	-20°C up to 60°C	-20°C up to 60°C	-20°C up to 60°C	-20°C up to 60°C
Temperature range (storage)	0°C up to 40°C	0°C up to 40°C	0°C up to 40°C	0°C up to 40°C
Water dust resistance	IP56	IP56	IP56	IP56
Cell configuration	4S16P	4S32P	4S20P	8S32P
Cell data	26650	26650	32700	26650
Cell chemist	LiFePO4, lithium Iron Phosphate battery	LiFePO4, Lithium Iron Phosphate battery	LiFePO4, Lithium Iron Phosphate battery	LiFePO4, Lithium Iron Phosphate battery
Plastic Case	ABS black	ABS black	ABS black	ABS black

12 VDC 50 Ah / 12 VDC 100 Ah

Different Rate Discharge Curve at 25°C

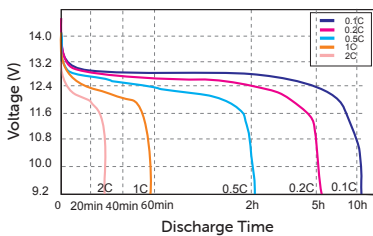

12 VDC 50/100/150 Ah / 24 VDC 100 Ah

Different DOD Discharge Cycle Life Curve @1C

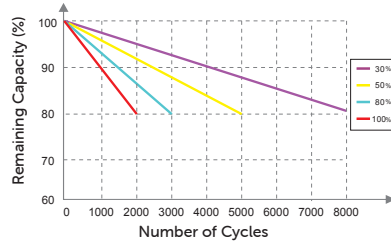

24 VDC 100 Ah

Different Rate Discharge Curve at 25°C

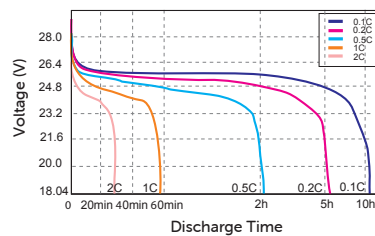

State of Charge Curve at 0.5C 25

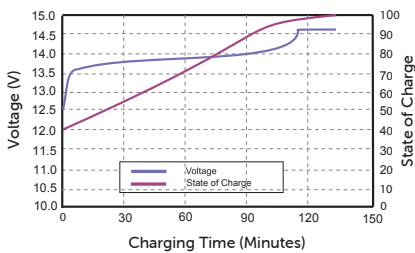

12 VDC 150 Ah

Discharge capacity at various temperatures Discharge at 1C

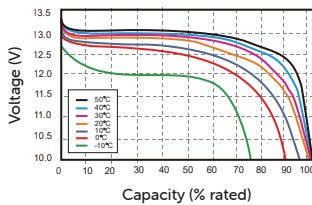

State of Charge Curve at 0.5C 25

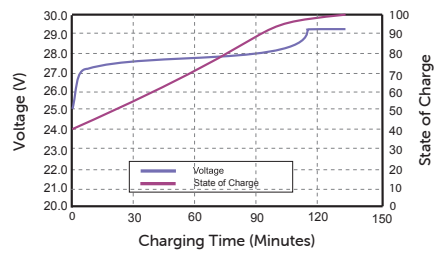

Lithium Power Basic Dimensions

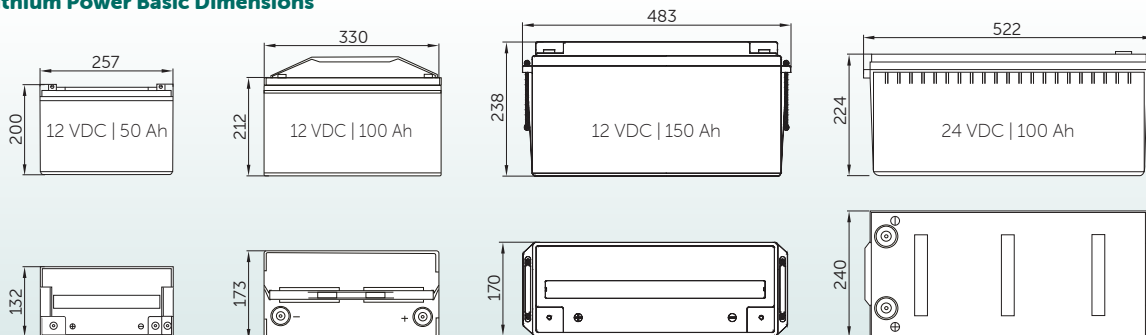

Premium Lithium Batteries

from small to large systems

Over the last 20 years, this kind of batteries has become incredibly popular thanks to the use of electric cars. The battery capacities have increased and there has been a significant rise in their use on yachts, motorhomes and cabins in recent years. WhisperPower has the right type of Lithium Battery for every application.

Technology

- Lithium Iron Phosphate battery technology
- LiFePO4 cells of the highest quality used
- As a result perfect thermal stability and safety
- Short circuit proof
- Integrated electronics for cell balancing
- Cobalt free

Features

- Long life time > 5000 cycles
- Deep cycle, DOD 90 %
- Fast re-charge, (up to 100 % of Ah capacity) fully charged in 1 hour
- Higher ambient operating temperatures allowed
- Small and light weight, 3 times less than lead acid batteries
- Made in the Netherlands



Models & Battery Sizing

- Series connection to create large 24 / 48 VDC banks
- Communication cables to keep batteries in balance
- Battery monitoring: wizard over internet, remote 5, 7 and 10 inch touch panel optional



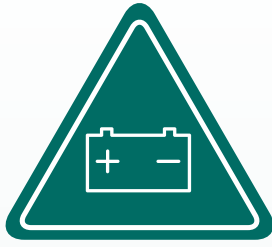

Safety

- Passive safety, even without electronics the batteries remain safe
- In case of fire extinguishable with water
- Integrated safety measures



WhisperConnect / CAN connection

- Easy accessible communication ports
- Plug and Play connections between batteries and WIB box
- Connectable in a direct way via WIB box to WhisperTouch panels



Battery monitoring

- Connection for WhisperTouch 7"
- Simple integration into complete WhisperPower system
- 5 inch Touch Battery Monitor optional
- Remote read-out via WhisperCare 

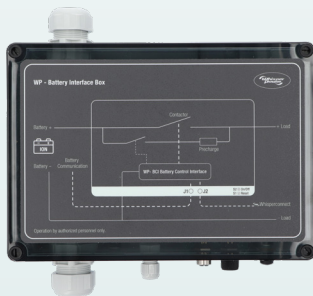

WIB Interface

- Optional WhisperInterface Box with control board for switching between multiple batteries
- 2 x 95 mm² connections per battery pole
- Integrated fuse, 32 VDC - 500 A
- CAN Open port as standard for interfacing / monitoring



Modular DC Distribution Assembly

- Essential heavy duty DC connectors
- To be mounted between battery bank and DC Consumers
- Includes high current busbars and fuse holders and fuses
- Option: integration of the BMS electronic device (see picture)



Robust casing, accessible connectors

- Specially designed casing for extreme environments
- Flexible adaptive Casing technology applied
- BMS electronics integrated, protected against moisture
- Heavy duty battery terminals and easy accessible fuse

Lithium Power Plus

Batteries 12 VDC | 210/340 Ah

Lightweight Lithium Batteries, 23 kg / 50.7 lb or 33 kg / 72.7 lb. Suitable to configure powerful 12, 24 or 48 VDC battery banks. Supplied with all necessary accessories.



Features

- Long Life Lithium battery
- Lithium Phosphate (LiFePO4)
- Most safe Lithium technology today
- Superior abuse tolerance
- Integrated BMS (Battery Management System)
- Glass fibre reinforced plastic (GRFP) casing, Aluminum / PE sandwich side panels
- 2 x 95 mm² wire connection per terminal
- Integrated fuse, 32 VDC / 500 A
- WhisperConnect interface for battery monitoring
- Battery monitoring / historical / time remaining
- Adaptive cell balancing
- Serial string equalisation
- Serial connection 24 / 48 VDC





Power Battery Plus Series

	12 VDC 210 Ah	12 VDC 340 Ah
Article Number	40290209	40290219
TECHNICAL SPECIFICATIONS		
Cell Type / Chemistry	Prismatic - LiFePO4	Prismatic - LiFePO4
Battery NR code	IFpP/36/130/195	IFpP/41/173/205
Dimensions (W x D x H) in mm	417 x 227 x 314	417 x 227 x 314
Dimensions (W x D x H) in inch	16.4 x 8.9 x 12.4	16.4 x 8.9 x 12.4
Weight	23 kg / 50.7 lb	33 kg / 72.7 lb
Ingress Protection	IP50	IP50
Nominal voltage (VDC)	13.2 VDC	12.8 VDC
Maximum voltage	15.4 VDC	15.4 VDC
End charge voltage	14.3 VDC	14.3 VDC
Maximum charge current 100/c	210 A	320 A
Maximum float charge current	70 A	100 A
Minimum battery voltage	8 VDC	8 VDC
Minimum float charge	10 VDC	10 VDC
Maximum discharge current	500 A	500 A
Pulsed discharge current (10 sec.)	800 A	800 A
Pulsed discharge current (60 sec.)	600 A	600 A
Usable battery capacity at 20°C	210 Ah / 2688 Wh	320 Ah / 4352 Wh
Usable battery capacity at -20°C	130 Ah / 1716 Wh	200 Ah / 2560 Wh
Usable capacity / in comparison to lead acid battery	420 Ah	600 Ah
Charge method	Constant voltage IU	Constant voltage IU
Temperature range (charging)	0°C to 45°C	0°C to 45°C
Temperature range (discharging)	-20°C up to 60°C	-20°C up to 60°C
Temperature range (storage)	-20°C up to 60°C	-20°C up to 60°C
COMPLIANCE SPECIFICATIONS		
Certifications	CE, FCC, UN 38.3, UN ECE R10.06, UL 1642 (Cells)	CE, FCC, UN 38.3, UN ECE R10.06, UL 1642 (Cells)
Shipping Classification	UN 3480	UN 3480



Lithium Batteries Power Plus Accessories

LITHIUM BATTERIES - TECHNOLOGY: LIFEPO4 (LITHIUM IRON PHOSPHATE) - FOR 12 / 24 / 48 VDC SYSTEMS

Article Number	Definition	
50214815	WP Power Plus Whisper Interface box WIB 12 VDC / 600 A	
50214817	WP Power Plus Whisper Interface box WIB 24 VDC / 600 A	
50214819	WP Power Plus Whisper Interface box WIB 48 VDC / 600 A	
40290253	WP Power Plus Relay 9 - 36 VDC / 500 A	
40290254	WP Power Plus Relay 12 - 42 VDC / 190 A Bi-stabile relay + cable 1 metre	
40290255	WP Power Plus CAN-bus cable 0.6 metre	
40290256	WP Power Plus CAN-bus Power cable	
40290257	WP Power Plus CAN-bus splitter	
40290258	WP Power Plus CAN-bus terminator female	
40290259	WP Power Plus CAN-bus terminator male	
40290340	WP Power Plus CAN-bus cable to WhisperConnect	
40290346	WP Lithium Power Plus – bracket kit 12 VDC / 210 Ah / 340 Ah	



WP Power Plus Whisper Interface box WIB

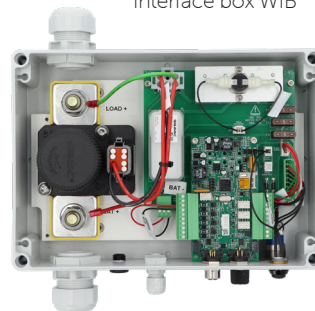

ART. NR. 40290255

WP Power Plus CAN-bus cable 0.6 metre



ART. NR. 40290258

WP Power Plus CAN-bus terminator female



ART. NR. 40290259

WP Power Plus CAN-bus terminator male



ART. NR. 40290253

WP Power Plus Relay 9 -36 VDC / 500 A



ART. NR. 40290254

WP Power Plus Relay 12 - 42 VDC / 190 A Bi-stabile Relay + cable 1 metre



ART. NR. 40290256

WP Power Plus CAN-bus Power cable

Lithium Power Plus

Modular Battery Rack System

The days of choosing lead acid batteries or niCAD batteries for backup storage or to operate inverters are over. Lithium batteries are the sustainable and suitable alternative for DC power systems, inverter/generator replacement solutions or supplementary systems for peak/energy shaving purposes.



Safety

- In case of fire extinguishable with water
- Integrated safety measures
- No risk of thermal runaway
- Safe and space saving reliable energy storage
- Passive safety, even without electronics the batteries remain safe



For horizontal or vertical installation

Stable and safe to operate

Pre-installed busbars and interface connections. BMS integrated

Drawer system for cells

Light weight aluminum rack

Front access

Designed for harsh marine and mobile use

Plug and Play installation

DC + and - Ready to connect

DNV Approval (optional)

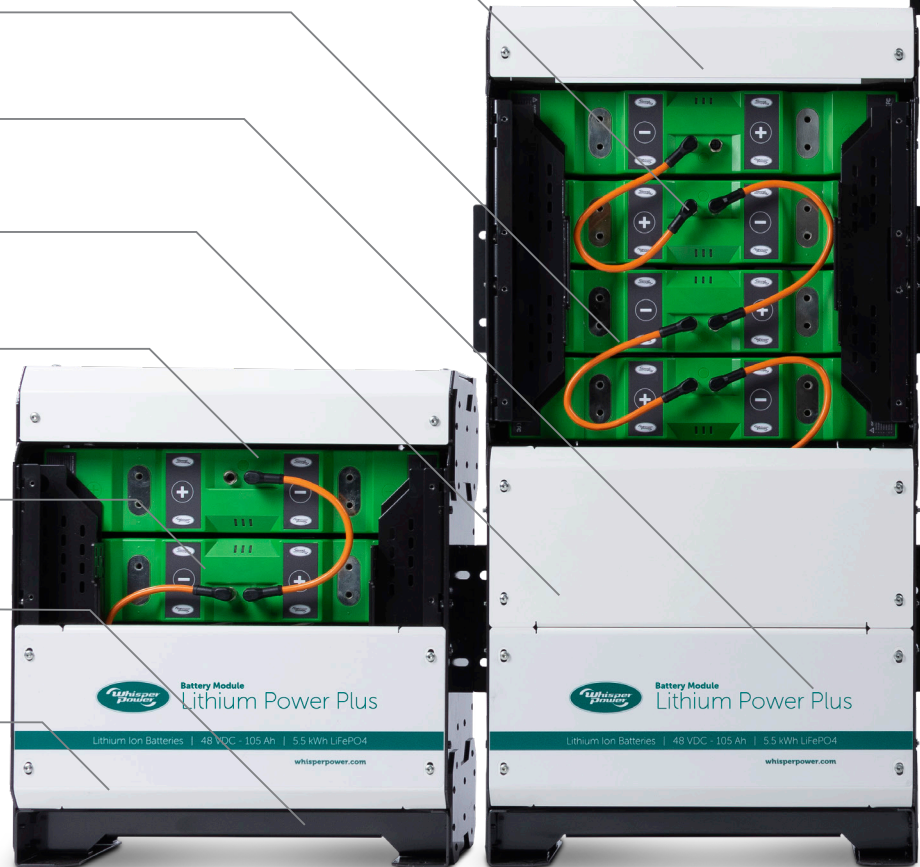

Why Lithium?

High quality 12 VDC Lithium Iron Phosphate (LiFePO4) cells are the basis for WhisperPower's new Lithium storage systems. The new Lithium Power Plus Battery Racks are a sustainable and highly energy dense solution to store electrical energy for use "on demand". Due to the specific characteristics of the WhisperPower LFP ferro Lithium batteries, the battery pack(s) can be charged and discharged at high Amps.

Sustainable and cleaner for the user

Further electrification to replace or supplement fossil power solutions reduces the carbon footprint on a substantial basis. In addition, large cost savings can be achieved because the fossil power system can be used much more efficiently. A higher up-front investment is recouped within a short time.

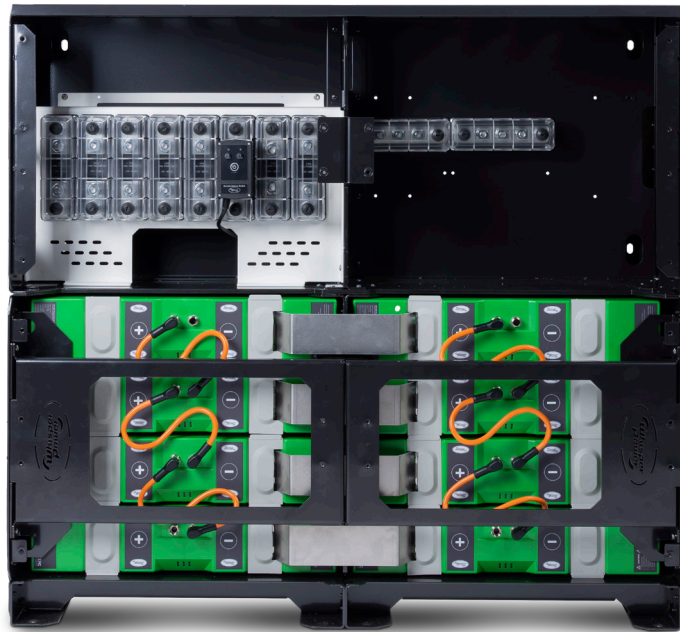

Custom Build modular battery rack with integrated DC-distribution

Lithium Power Plus modular battery rack system

- Light weight, modular rack design
- For horizontal or vertical mounting
- Pre-installed busbars and cabling
- Easy installation, Plug and Play
- Configurations from 12 – 48 VDC
- Advanced BMS integration with accurate battery monitoring
- Real time and historical cloud-based surveillance (WhisperCare) (optional)
- DNV type approval (optional)
- Safe LiFePO4 chemistry, of the highest density

The added value of WhisperPower

All Lithium battery solutions can be supplied just "as a battery". However, we offer our customers a total solution that eliminates the risk of the user's battery not being charged, discharged or monitored properly. The system approach goes beyond simply supplying a WhisperPower battery charger or combination inverter/charger. If required, we can supply a complete diesel fuel based fast charge system in combination with the Lithium Power Plus rack with integrated BMS, DC bus bar(s) distribution including fuses and an advanced monitoring system that monitors the behavior of the cells inside the battery down to the cell level: WhisperCare. 

Added value services from WhisperPower

- Full integration of (fast) chargers, DC – AC inverters, solar power and back-up generators, all from one brand
- Service & support at location on a world wide base
- Total Power System Design
- Battery System Design



Lithium Power Plus Series

	24 VDC 210 Ah 5.5 kWh	24 VDC 420 Ah 11.1 kWh	24 VDC 630 Ah 16.6 kWh
Article Number	40290223, horizontal 40290203, vertical	40290225, horizontal 40290205, vertical	40290226, horizontal 40290206, vertical
TECHNOLOGY			
Chemistry	LiFePO4	LiFePO4	LiFePO4
Module configuration (12 VDC module)	2s2p	2s4p	2s6p
Number of modules	4	8	12
Nominal voltage	24 VDC	24 VDC	24 VDC
Open circuit voltage	26.4 VDC	26.4 VDC	26.4 VDC
Nominal capacity	210 Ah	420 Ah	630 Ah
Nominal energy	5.5 kWh	11.1 kWh	16.6 kWh
Cycle Life DOD 80 %	> 3500 cycles (at 1C charge/ discharge, 80 % DOD)	> 3500 cycles (at 1C charge/ discharge, 80 % DOD)	> 3500 cycles (at 1C charge/ discharge, 80 % DOD)
Self discharge	< 3 % per month	< 3 % per month	< 3 % per month
Weight modules (excl. Aluminum cabinet)	40 kg / 88.2 lb	80 kg / 176.4 lb	120 kg / 264.6 lb
DISCHARGE			
Discharge cut-off voltage	21.6 VDC	21.6 VDC	21.6 VDC
Recommended discharge current	105 A (0.5 C)	210 A (0.5 C)	315 A (0.5 C)
Maximum discharge current	210 A (1.0 C)	420 A (1.0 C)	630 A (1.0 C)
Discharge pulse current	420 A (2.0 C)	840 A (2.0 C)	1260 A (2 C, 10 sec. SOC > 60 %)
Fuse protection	400 A T-class	2*400A T-class	3*400 A T-class
CHARGE			
Charge method	CCCV	CCCV	CCCV
Maximum charge voltage	29.8 VDC	29.8 VDC	29.8 VDC
Recommended charge voltage	28.6 VDC	28.6 VDC	28.6 VDC
Recommended charge current	105 A (0.5 C)	210 A (0.5 C)	315 A (0.5 C)
Continuous charge current	210 A (1.0 C)	420 A (1.0 C)	630 A (1.0 C)
CONFIGURATION			
Series configuration	Yes, up to 4 (maximum)	Yes, up to 4 (maximum)	On request
Parallel configuration	Yes, up to 2 (maximum)	Yes, up to 2 (maximum)	On request
Redundant mode	Yes, using double BIM	Yes, using double BIM	Yes, using double BIM
ENVIRONMENTAL			
Operating temperature charge	0 up to 55°C / 32 up to 131°F	0 up to 55°C / 32 up to 131°F	0 up to 55°C / 32 up to 131°F
Operating temperature discharge	-20 up to 55°C / -4 up to 131°F	-20 up to 55°C / -4 up to 131°F	-20 up to 55°C / -4 up to 131°F
Storage temperature	-20 up to 45°C / -4 up to 113°F	-20 up to 45°C / -4 up to 113°F	-20 up to 45°C / -4 up to 113°F
Humidity (Non-condensing)	< 95 %	< 95 %	< 95 %
MECHANICAL			
Power connections	M10 stud, maximum 20 NM	M10 stud, maximum 20 NM	2*M10 stud, maximum 20 NM
Cable connections	Option: Top or Bottom	Option: Top or Bottom	Option: Top or Bottom
IP-Protection class	IP 66 cell IP20 connection	IP 66 cell IP20 connection	IP 66 cell IP20 connection
Cooling	Natural air convection	Natural air convection	Natural air convection
Module material	PC-ABS UL94-V0	PC-ABS UL94-V0	PC-ABS UL94-V0
Battery case material	Aluminum Powder coat	Aluminum Powder coat	Aluminum Powder coat
Dimensions (W x D x H) in mm	465 (540) x 280 x 530	465 (540) x 280 x 920	465 (540) x 280 x 1310
Dimensions (L X H X W) inches	18.3 (21.3) x 11 x 20.9	18.3 (21.3) x 11 x 36.2	18.3 (21.3) x 11 x 51.6
Total weight module plus cabinet	± 55 - 60 kg / 121 - 132 lb	± 100 - 110 kg / 220 - 243 lb	± 150 - 160 kg / 331 - 353 lb



SAFETY

Battery Management System (BMS)	External WP-BIM module
Balancing	Passive method
Communication CAN-bus	WhisperConnect/NMEA2000
EMC: Emission	EN-IEC 61000-6-3:2007 / A1:2011/C11:2012
EMC: Immunity	EN-IEC 61000-6-1:2007
Low voltage directive	EN 60335-1:2012/AC:2014
Certifications	CE, FCC, UN 38.3, UL 1642 (Cells), UN ECE R10.06, EN/IEC 62620 (ESTRIN)
Shipping classification	UN 3480



48 VDC 105 Ah 5.5 kWh	48 VDC 210 Ah 11.1 kWh	48 VDC 315 Ah 16.6 kWh	48 VDC 420 Ah 22.2 kWh
40290231, horizontal 40290211, vertical	40290235, horizontal 40290215, vertical	40290236, horizontal 40290216, vertical	40290218
LiFePO4	LiFePO4	LiFePO4	LiFePO4
4s1p	4s2p	4s3p	4s4p
4	8	12	16
48 VDC	48 VDC	48 VDC	48 VDC
52.8 VDC	52.8 VDC	52.8 VDC	52.8 VDC
105 Ah	210 Ah	315 Ah	420 Ah
5.5 kWh	11.1 kWh	22.2 kWh	22.2 kWh
> 3500 cycles (at 1C charge/ discharge, 80 % DOD)	> 3500 cycles (at 1C charge/ discharge, 80 % DOD)	> 3500 cycles (at 1C charge/ discharge, 80 % DOD)	> 3500 cycles (at 1C charge/ discharge, 80 % DOD)
< 3 % per month	< 3 % per month	< 3 % per month	< 3 % per month
40 kg / 88.2 lb	80 kg / 176.4 lb	120 kg / 264.6 lb	160 kg / 352.7 lb
43.2 VDC	43.2 VDC	43.2 VDC	43.2 VDC
52.5 A (0.5 C)	105 A (0.5 C)	157 A (0.5 C)	210 A (0.5 C)
105 A (1.0 C)	210 A (1.0 C)	315 A (1.0 C)	420 A (1.0 C)
210 A (2 C, 10 sec. SOC >60 %)	420 A (2 C, 10 sec. SOC > 60 %)	630 A (2 C, 10 sec. wSOC > 60 %)	840 A (2.0 C)
225A T-class	2*225A T-class	3*225A T-class	600 A T-class
CCCV	CCCV	CCCV	CCCV
59.6 VDC	59.6 VDC	59.6 VDC	59.6 VDC
57.2 VDC	57.2 VDC	57.2 VDC	57.2 VDC
52.5 A (0.5 C)	105 A (0.5 C)	157.5 A (0.5 C)	210 A (0.5 C)
105 A (1.0 C)	210 A (1.0 C)	315 A (1.0 C)	420 A (1.0 C)
No	No	No	No
Yes, up to 4 (maximum)	Yes, up to 2 (maximum)	No	No
Yes, using double BIM	Yes, using double BIM	Yes, using double BIM	Yes, using double BIM
0 up to 55°C / 32 up to 131°F	0 up to 55°C / 32 up to 131°F	0 up to 55°C / 32 up to 131°F	0 up to 55°C / 32 up to 131°F
-20 up to 55°C / -4 up to 131°F	-20 up to 55°C / -4 up to 131°F	-20 up to 55°C / -4 up to 131°F	-20 up to 55°C / -4 up to 131°F
-20 up to 45°C / -4 up to 113°F	-20 up to 45°C / -4 up to 113°F	-20 up to 45°C / -4 up to 113°F	-20 up to 45°C / -4 up to 113°F
< 95 %	< 95 %	< 95 %	<95 %
M10 stud, maximum 20 NM	M10 stud, maximum 20 NM	M10 stud, maximum 20 NM	M10 stud, maximum 20 NM
Option: Top or Bottom	Option: Top or Bottom	Option: Top or Bottom	Option: Top or Bottom
IP 66 cell IP20 connection	IP 66 cell IP20 connection	IP 66 cell IP20 connection	IP 66 cell IP20 connection
Natural air convection	Natural air convection	Natural air convection	Natural air convection
PC-ABS UL94-V0	PC-ABS UL94-V0	PC-ABS UL94-V0	PC-ABS UL94-V0
Aluminum Powder coat	Aluminum Powder coat	Aluminum Powder coat	Aluminum Powder coat
465 (540) x 280 x 530	465 (540) x 280 x 920	465 (540) x 280 x 1310	920 (995) x 340 x 995
18.3 (21.3) x 11 x 20.9	18.3 (21.3) x 11 x 36.2	18.3 (21.3) x 11 x 51.6	36.2 (39.2) x 13.4 x 39.2
± 55 - 60 kg / 121 - 132 lb	± 100 - 110kg / 220 - 243 lb	± 150 - 160 kg / 331 - 353 lb	± 200 - 210 kg / 441 - 463 lb

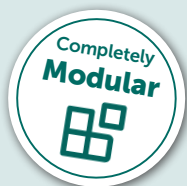

**Also for horizontal mounting
Even larger on request**

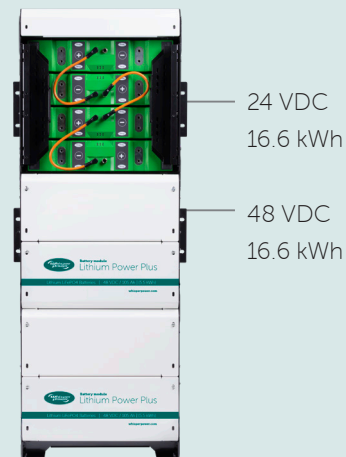
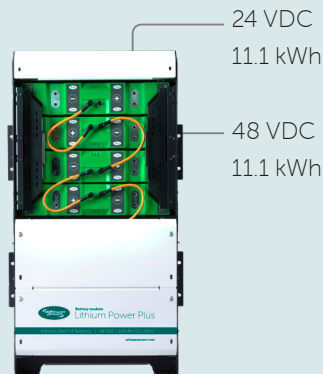
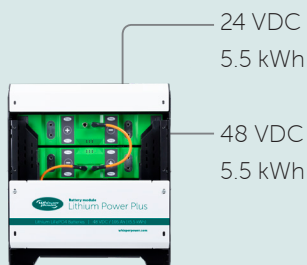

WhisperPower

AC Power Distribution

An electrical system is only as reliable as its weakest link. WhisperPower supplies high-quality components to ensure a quick and safe installation of the 230 VAC or 117 VAC system. Handy building blocks that save a lot of time during the installation of a complete system.



Power Distribution

Transfer Switches

AC power distribution between various AC sources

[Go to Page 84](#)

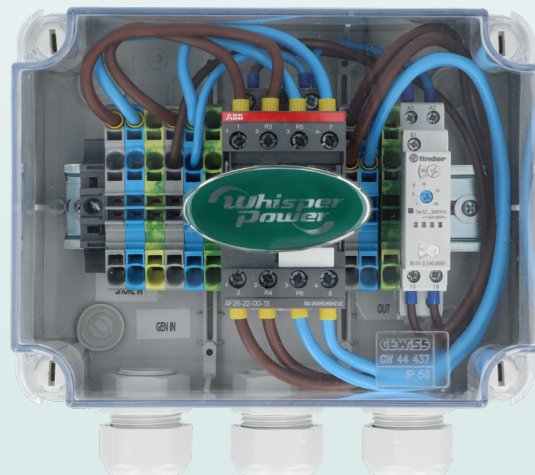
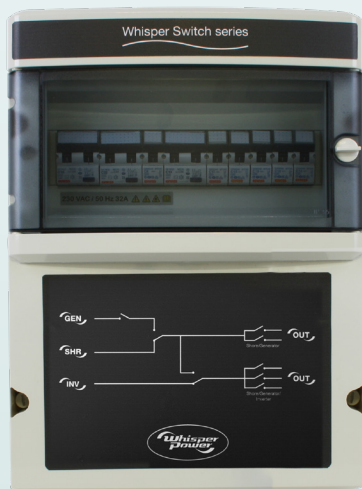

WP-GI

Galvanic protection

Protection of in-water metal hulls against electrolyte and severe damage)

[Go to Page 90](#)



Safe and reliable

Land power connections

[Go to Page 94](#)

Offgrid objects, vehicles or vessels can be easily connected to a (temporary) grid supply or AC generators thanks to WhisperPower's solid connection material. We also supply skin/hull-through devices and sockets that are water-proof and comply with European safety requirements.



Power distribution

AC Power Distribution

To connect a vehicle or boat safely to land power a number of safety devices are needed. Having covered the actual land connection, we will now look at the extra components needed to be ensured of a safe and certified installation.

- Galvanic separators in the form of a simple galvanic isolator or isolation transformer: see page 90
- Earth leakage protection in the form of a cabinet with breaker
- A fuse box or distribution system is necessary for extensive installations with AC power consumers connected directly to the land power.
- If there are multiple AC power sources present, such as an inverter and generator, then it is recommended to install an automatic switching system.

The WhisperPower "All-in-One" systems and the WPC contain the various switching and distribution functions already integrated.

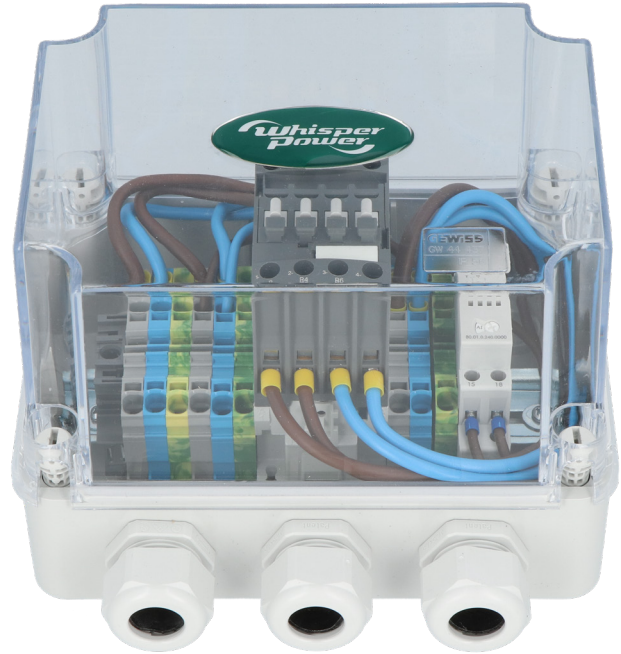

WhisperSwitch Transfer System

The traditional WhisperSwitch systems regulate the power distribution between energy sources fully automatically. AC and generator / inverter IN, 230 / 120 VAC onboard groups OUT, everything in one cabinet. The connected devices make use of the sources (maximum two) which are available at the time.

WhisperSwitch is available in the following versions:

- 2 inputs, for example land / inverter or land / generator with 1 output. Capacity 6 kW / 26 A at 230 VAC / 50 Hz
- 2 inputs, for example land / inverter or land / generator with 1 output for consumers. Capacity 10 kW / 42 A at 230 VAC / 50 Hz
- 2 inputs, 1 output. Capacity 6 kW / 50 A at 120 VAC / 60 Hz
- 2 inputs, 1 output. Capacity 10 kW / 83 A at 120 VAC / 60 Hz





AC Transfer Systems: 3 inputs

These analogue switching devices are able to feed the onboard power supply from three different sources: land power, generator and inverter. There are three output circuits, available with different capacities.

As an alternative solution, it is also possible to install two standard WhisperSwitches.

- switch from land to generator
- switch between generator and inverter

Earth Leakage Protection

WhisperPower supplies Plug and Play earth leakage breakers for single and three phase systems. An earth leakage switch protects the electrical installation against leakage current preventing dangerous situations.

We supply the WP-Shore Connect system as a Plug and Play solution: the land power is connected on one side and the onboard installation on the other. See page 90 for the 100 % safe solution with the WP-GI isolation transformer.

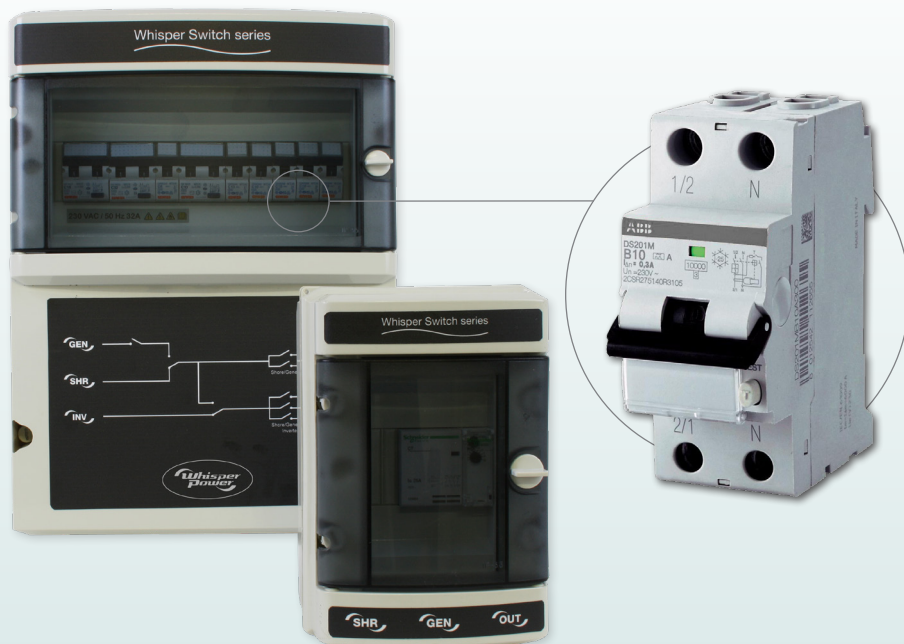



WhisperSwitch

	6 – 6 kW (2 X IN, 1 X OUT)	10 – 10 kW (2 X IN, 1 X OUT)	6 – 5 kW (2 X IN, 1 X OUT)
Article Number	50214670	50214671 50214673 (10 kW 120 VAC 1-phase)	50214672
TECHNICAL SPECIFICATIONS			
Nominal input voltage	230 VAC (50 / 60 Hz)	230 VAC (50 / 60 Hz)	120 VAC
Input voltage range	200 - 250 VAC	200 - 250 VAC	100 - 250 VAC
Number of AC inputs	2 x (Shore/ Generator)	2 x (Shore/ Generator)	2 x (Shore/ Generator)
Number of AC outputs	1	1	1
Dimensions (W x D x H) in mm	140 x 100 x 240	210 x 100 x 240	140 x 100 x 240
Weight	1 kg	1.7 kg	1 kg
TECHNICAL SPECIFICATIONS			
Nominal output current generator	26 A	42 A	45 A
Nominal input current land power	26 A	42 A	45 A
Nominal output current inverter	25 A	32 A	45 A
Earth leakage switch	Not integrated	Not integrated	Not integrated
Input generator monitoring	Continuous voltage and frequency monitoring		
Delay generator input	0 - 10 sec. (adjustable)	0 - 10 sec. (adjustable)	0 - 10 sec. (adjustable)
Nominal output current	25 A	25 A	25 A
Automatic fuses	Not integrated	Not integrated	Not integrated
Energy consumption (AC, all inputs)	27 W	27 W	27 W
Power consumption (inverter capacity only)	< 1 W	< 1 W	< 1 W
Switching time	Switch ON 12 - 22 ms / switch OFF 4 - 19 ms		
Temperature range (specified)	-5 up to 60°C / 23 up to 140°F	-5 up to 60°C / 23 up to 140°F	-5 up to 60°C / 23 up to 140°F
Temperature range (ambient)	-25 up to 70°C / -13 up to 158°F	-25 up to 70°C / -13 up to 158°F	-25 up to 70°C / -13 up to 158°F
Temperature range (not working)	-60 up to 80°C / -76 up to 176°F	-60 up to 80°C / -76 up to 176°F	-60 up to 80°C / -76 up to 176°F
Relative humidity	Maximum 95 %, non-condensing	Maximum 95 %, non-condensing	Maximum 95 %, non-condensing
Frequency monitoring	Yes	Yes	Yes
Cable diameter	0.5 - 10 mm ² / AWG 20 - 7	0.5 - 10 mm ² / AWG 20 - 7	0.5 - 10 mm ² / AWG 20 - 7
International Protection rating	IP23	IP23	IP23

AVAILABLE ON REQUEST

WP-AC TRANSFER SYSTEM SWITCH

for 3 phase generator, inverter

for 25 and 32 kW



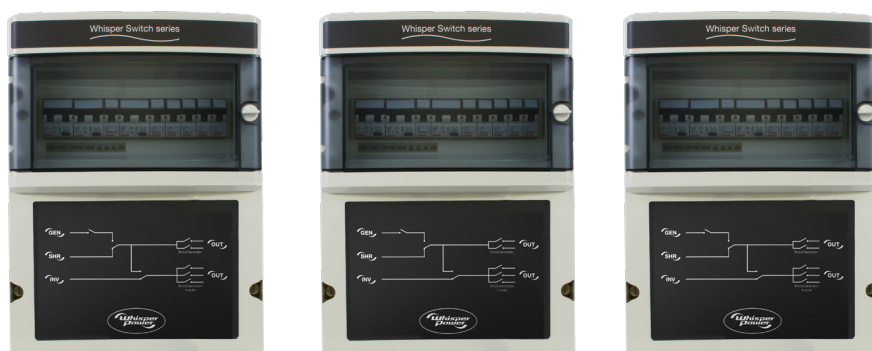

AC Transfer System Switch

	5 kW	10 kW	16 kW
Article Number	50214690	50214691	50214692
GENERAL SPECIFICATIONS			
Power rating	5 kW	10 kW	16 kW
Nominal input voltage	230 VAC (50 / 60 Hz)	230 VAC (50 / 60 Hz)	230 VAC (50 / 60 Hz)
Input voltage range	200 - 250 VAC	200 - 250 VAC	200 - 250 VAC
No. of AC inputs	3 (shore, generator, inverter)	3 (shore, generator, inverter)	3 (shore, generator, inverter)
No. of AC outputs	3 output groups	3 output groups	3 output groups
Dimensions (W x D x H) in mm	261 x 144 x 340	261 x 144 x 340	261 x 144 x 340
Dimensions (W x D x H) in inch	10.3 x 5.7 x 13.4	10.3 x 5.7 x 13.4	10.3 x 5.7 x 13.4
Weight	4.4 kg / 9.7 lb	4.4 kg / 9.7 lb	4.4 kg / 9.7 lb
TECHNICAL SPECIFICATIONS			
LED indicators on cabinet	Power sources present indication and 'load on inverter' mode		
Nominal input current generator	25 A	42 A	68 A
Nominal input current land power	25 A	42 A	68 A
Nominal input current inverter	25 A	42 A	68 A
Earth leakage switch	Not integrated	Not integrated	Not integrated
Input generator monitoring	Continuous voltage and frequency monitoring		
Delay generator input	0 - 10 sec. (adjustable)	0 - 10 sec. (adjustable)	0 - 10 sec. (adjustable)
Nominal output Short circuit current	25 A	42 A	68 A
Nominal output current	25 A	42 A	68 A
Automatic fuses	No, depends on system	No, depends on system	No, depends on system
Energy consumption (AC, all inputs)	27 W	27 W	27 W
Power consumption (inverter capacity only)	< 1 W	< 1 W	< 1 W
Switching time	switch ON 12-22 ms / switch OFF 4 - 19 ms		
Temperature range (specified)	-5°C up to 60°C / 23 up to 140°F	-5°C up to 60°C / 23 up to 140°F	-5°C up to 60°C / 23 up to 140°F
Temperature range (ambient)	-25°C up to 70°C / -13 up to 158°F	-25°C up to 70°C / -13 up to 158°F	-25°C up to 70°C / -13 up to 158°F
Temperature range (not working)	-60°C up to 80°C / -76 up to 176°F	-60°C up to 80°C / -76 up to 176°F	-60°C up to 80°C / -76 up to 176°F
Relative humidity	Maximum 95 %, non-condensing	Maximum 95 %, non-condensing	Maximum 95 %, non-condensing
Frequency monitoring	Yes	Yes	Yes
Cable diameter	0.5 - 10 mm ² / AWG 20 - 7, remote control 0.14 - 2.5 mm ² / AWG 26 - 13		
International Protection rating	IP23	IP23	IP23

WP-IG

Isolation Guard

For optimal safety, vehicles using 230 VAC 50 Hz Inverter / Combi / Genset power as well as power from the grid line to operate the various appliances require the installation of the WP-IG Isolation Guard.



ART. NR. 60110115

WP- Isolation Guard Inverter

ART. NR. 60110116

WP- Isolation Guard Combi

This is a fully automatic safety device that measures the electrical resistance in the AC wiring and should it detect a potential risk to safety, switches the power off immediately. The system works as follows: when the WhisperPower Inverter or Combi is turned on, the WP-IG Isolation Guard executes a short system test. Once the test is complete the green LED on the device will illuminate. The internal relay then allows the 230 VAC installation inside the vehicle to be operated by the Inverter and / or Combi inverter / charger.

WhisperPower offers a selection of products based on safe work principles for users of various vehicles which are fitted with an AC power installation (230 VAC / 50 Hz or 120 VAC / 60 Hz). In most countries safety regulations for low voltage installations (such as NEN 1010 in the Netherlands) are classified as practical guidelines and working standards to be followed by the vehicle builder or installer. Our safety and protection products include 230 VAC / 50 Hz Isolations Guards, Isolation transformers and professional AC distribution devices.

WP-Isolation Guard Combi

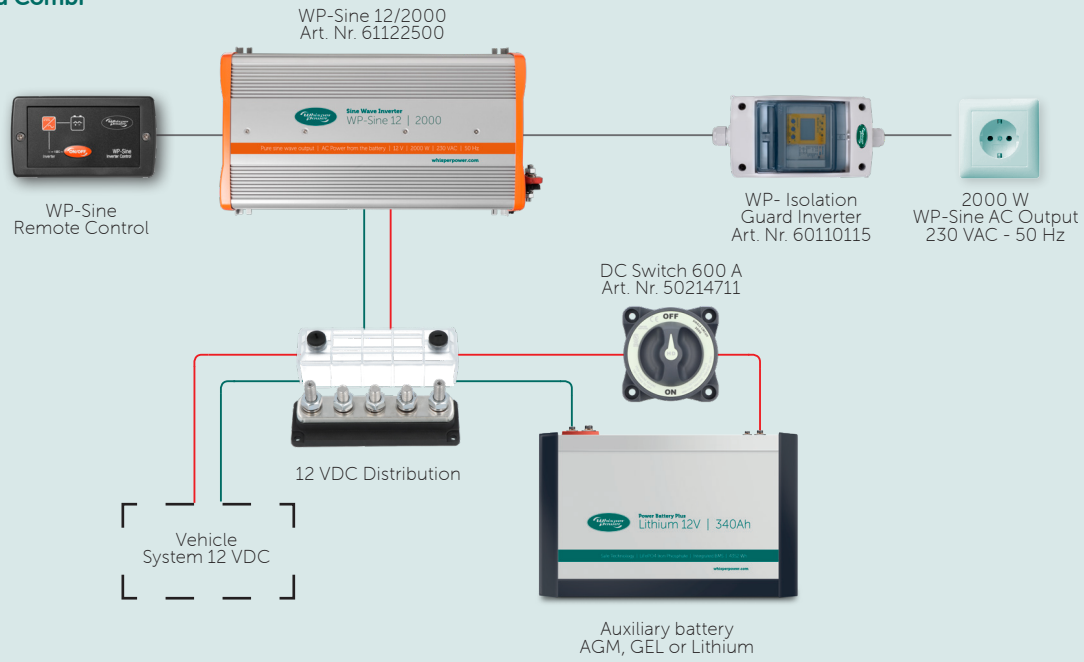

WP-Isolation Guard Combi

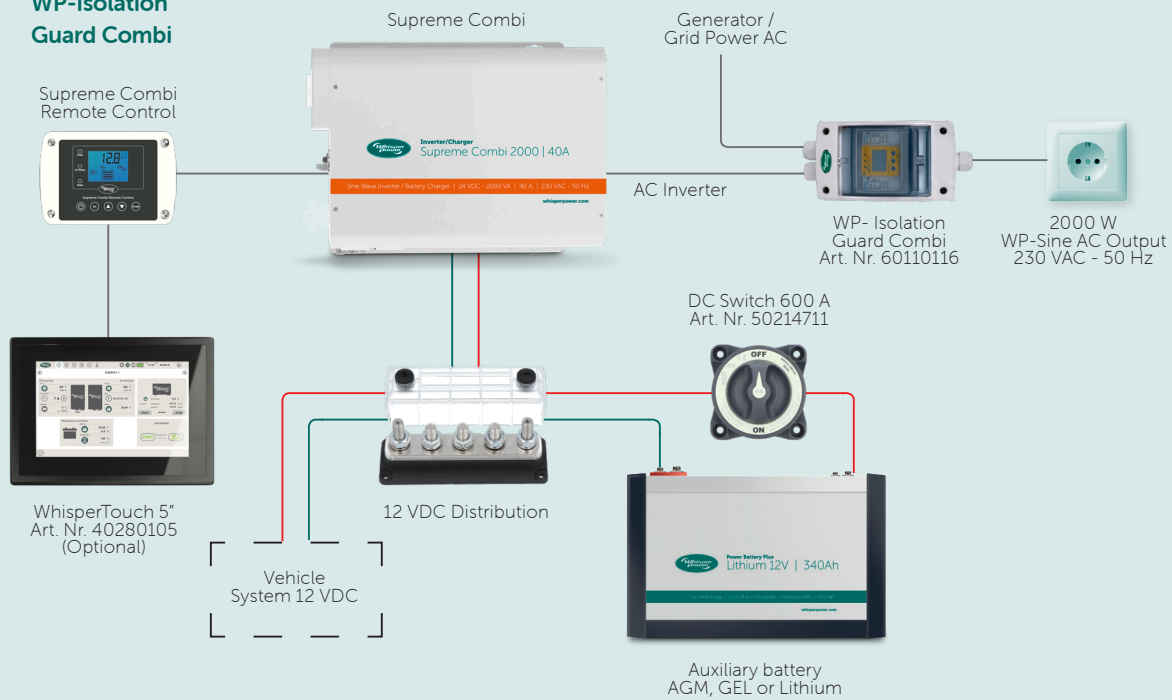

Isolation Guard Series

	ISOLATION GUARD INVERTER	ISOLATION GUARD COMBI
Article Number	60110115	60110116
BRIEF SPECIFICATIONS		
Nominal voltage	230 VAC / 110 VAC	230 VAC / 110 VAC
Switching Current	25 A	25 A
Switching Capacity	5750 W	5750 W
Frequency	50-60 Hz	50-60 Hz
International Protection rating	IP65	IP65
Dimensions (W x D x H)	100 x 105 x 170 mm	100 x 105 x 170 mm
Weight	1.75 kg	2.05 kg



WP-GI

Galvanic protection

Connecting a yacht, ship or vehicle to land power can consequently lead to sustaining damage if galvanic isolation has not been taken in to account. Galvanic corrosion can drastically damage a vessel's underwater metal parts. Corrosion can be partially prevented by the application of galvanic anodes (sacrificial anodes) below the waterline. How effective an anode is depends on a good electrical connection, and is directly proportional to the surface area of the anode.



WhisperPower offers a selection of products to help minimize galvanic corrosion such as the cost effective galvanic isolator and the WP-GI isolation transformer.

What is a Galvanic Isolator

- It is a small metal enclosure containing electronics and semiconductors
- Optimizes the life of the galvanic anodes and protects metal parts on the boat against galvanic corrosion. It prevents stray currents from the land
- A WhisperPower Galvanic Isolator is connected to the anode and the equipotential system on board
- It lets through a nominal current of 30 A or 60 A

Why choose a WP-GI Isolation Transformer

- Installing a WP-GI is the best and safest solution
- The WP-GI is indispensable for steel or aluminum boats
- The ground loop between the land and ship is interrupted fully by the coil in the WP-GI, preventing galvanic corrosion
- The WP-GI has to be installed inside the boat, close to the land power connection - the AC on board installation is connected to the WP-GI output
- Power rating of 16 A and 32 A (2 x WP-GI's in parallel)
- Built-in soft start suppresses inrush current and prevents the land fuses from tripping
- The WP-GI can also be adjusted for 120 VAC land power (and vice versa)
- Can be connected worldwide
- Absolutely silent, no humming

WP-GI 16

Galvanic Isolator 16 A



WP-GI 3600 - 110/230 VAC

Compact Isolation-Transformer 3600 VA
7200 VA by connecting 2 in parallel



WP-GI 32

Galvanic Isolator 32 A (230 VAC)



WP-GI 3600**WP-GI 3600 COMPACT ISOLATION TRANSFORMER**

Article Number 60110102

TECHNICAL SPECIFICATIONS

Application	Isolation transformer for electrical safety and protections against galvanic corrosion
Transformer type	Toroidal isolation transformer with two windings
Construction design	Special vibration damping mountings
Cooling	Temperature controlled increasing (uniform) fan cooling above 60°C temperature

WINDING INFORMATION

Nominal power	3600 VA
Nominal voltage	230 VAC / 110 VAC
Nominal frequency	50 Hz (60 Hz USA)
Nominal current	16 A / 32 A
Inrush current	Built-in soft start, < 4 A per transformer
Supply points	Primary, secondary, middle (110 VAC)
Windings (Material)	Copper
Temperature rise class	F 100 K
Isolation class	H 180 C
Isolation level	Class AC3
Impedance	Secondary < 3 % at 3600 VA

GENERAL

Consumption (no load)	21 W per transformer
Efficiency (At full load)	> 95 %
Ambient operating temperature	-10 up to 45°C, with power reduction up to 80°C
Storage temperature	-25 up to 85°C
Relative humidity during operation	Up to 95 %, non-condensing
Noise levels	< 4 dB(A); < 50 dB(A) with ventilator
User interface	No

PROTECTIONS

Current rating / short circuit	Not built-in, external fuse(s) subject to local regulations
Temperature protection	Automatic shut down at core temperature > 120°C
Too high voltage	Soft start protection with fuse
Earth isolation between windings	Conforms to ABYC, resistant against full leakage current
Safety standards	IEC 60079, IEC 60726

MECHANICAL SPECIFICATIONS

International Protection rating	IP21
Connection In / Out	Maximum 6 mm ²
Cable gland	22 mm
Dimensions (W x D x H) in mm	290 x 208 x 380
Mounting holes	M8
Weight	28.6 kg
Material housing	Sheet steel
Colour & finish	RAL9010 white + AE80104123621 black

ACCESSORIES ARTICLE NUMBER**IT IS RECOMMENDED TO INCORPORATE A EARTH LEAKAGE PROTECTION IN THE AC SUPPLY**

60110105	WP-GI alternative box for DIN-rail mounting
50214640	Shore power fuse 16 A / 230 VAC single phase, 3 core
50214641	Shore power fuse 25 A / 230 VAC single phase, 3 core
50214642	Shore power fuse 35 A / 230 VAC single phase, 3 core
50214645	WP-Energy Meter, 65 A phase and zero, for DIN-rail mounting

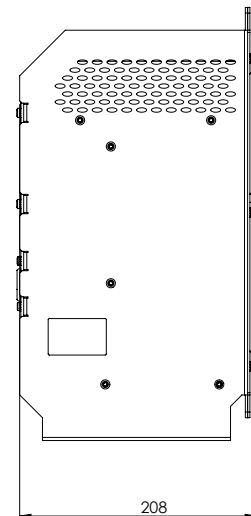
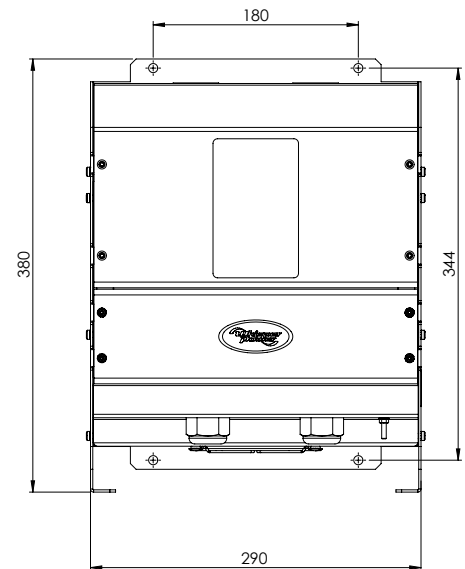
WP-GI 3600 - 110/230 VAC**Isolation Transformer**

WP-GI

Galvanic Isolator 16 A

WP-GI GALVANIC ISOLATOR 16 A

Article Number	60110140
Maximum current	16 A
Peak current	1600 A / 20 ms
Connection	2x M6
Cooling fins	Aluminum
International Protection rating	IP67
Material	Anodised Aluminum
Dimensions (W x D x H) in mm	200 x 60 x 120

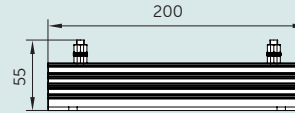
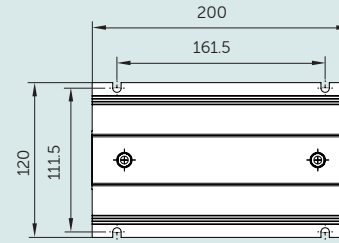
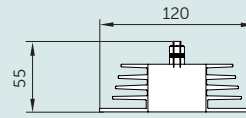

WP-GI

Galvanic Isolator 32 A

WP-GI GALVANIC ISOLATOR 32 A

Article Number	60110150
Maximum current	32 A
Peak current	1600 A / 20 ms
Connection	2x M6
Cooling fins	Aluminum
International Protection rating	IP67
Material	Anodised Aluminum
Dimensions (W x D x H) in mm	200 x 63 x 163

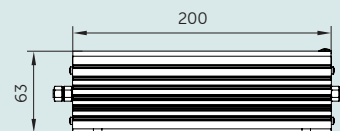
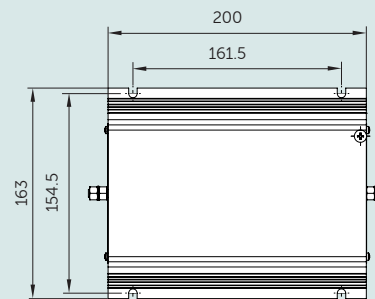
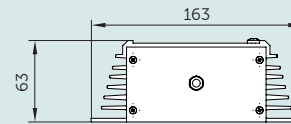

WP-GI

Galvanic Isolator 64 A

WP-GI GALVANIC ISOLATOR 64 A

Article Number	60110155
Maximum current	64 A
Peak current	6000 A / 20 ms
Connection	2x M6
Cooling fins	Aluminum
International Protection rating	IP67
Material	Anodised Aluminum
Dimensions (W x D x H) in mm	335 x 63 x 164

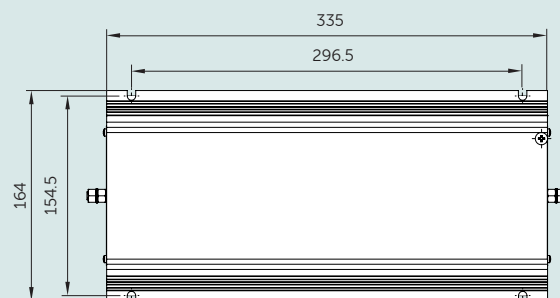
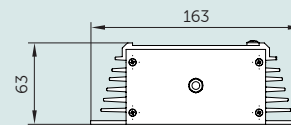

Safe and reliable

Land power connections

For movable objects, vehicles and vessels, WhisperPower provides convenient Plug and Play cable sets. This is the “life line” from land power to the object, ensuring that the technical equipment remains powered all the time.



A vital component of the land power connection is the battery charger which recharges and maintains the voltage for the service, starter and the bow thruster batteries.

The WhisperPower battery charger or inverter / charger Combi ensures that the battery remains in perfect condition throughout the whole year whilst also ‘buffering’ sufficient current to provide the various 12, 24 VDC and/or 120 / 230 VAC electrical devices with power whilst on board. The next few pages cover the necessary installation components to ensure uninterrupted and safe connection to land. All electrical thru-hull inlets have an LED indicator that turns on when the connection is successful.

Main ingredients for a reliable land power connection

- Complete cable sets for land to object connection, 15 or 25 metre, 16 or 32 Amps, complete with connectors / plugs
- Thru-hull stainless steel inlets
- Plugs to fit the inlets
- Cable storage case
- Industrial cable reel



CABLE SETS WITH IEC 60309 PLUGS (CABLE SET STORAGE BAG INCLUDED)

Article Number	50214751	50214752	50214741	50214742	50214744
TECHNICAL SPECIFICATIONS					
For use up to	16 A / 250 VAC	16 A / 250 VAC	25 A / 250 VAC	25 A / 250 VAC	32 A / 250 VAC
Cable	H07BQ-F 3G1, 50 mm ²	H07BQ-F 3G1, 50 mm ²	H07BQ-F 3G6,00 mm ²	H07BQ-F 3G6,00mm ²	H07BQ-F 3G6,00mm ²
IP Rating	IP56	IP56	IP56	IP56	IP56
Certification	CE	CE	CE	CE	CE
LED Power Indication	Yes	Yes	Yes	Yes	Yes
Length	15 m	25 m	15 m	25 m	25 m



WP-AC

Basic Kit 230 VAC "only"

Our Land Power Kit is a great solution for installers who want to reduce installation time and at the same time enhance the quality of the electrical system. A WhisperPower Shore Power kit consists of 15 metre yellow land power cable and storage bag, a compact 16 A stainless steel inlet with signal LED (power ON-OFF), a connection cable to plug into an electrical box with earth-leak protector (GFI) and a double socket with cable connection to the electrical box. All connections are waterproof, the whole system complies with CE regulations. Amperage 16 A. Optional: plug-in battery chargers or Combi's.

Article Number: 50214745

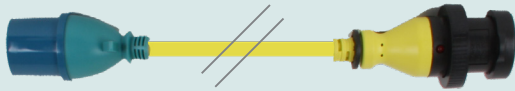

LAND POWER CORD SET P/N 2801

Dimension	Ø 8.5 mm
Temperature range	-40 up to 80 °C
Insulation class	IP56
Conductor area	3 x 1.5 mm ²
Voltage	250 VAC
Current	10 A
Length	15 m
Weight	2.1 kg

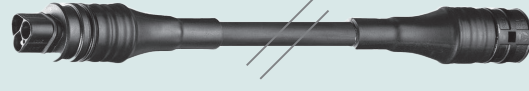

INTERNAL CABLE

Dimension	Ø 11.3 mm
Cable lengths	1 m / 2 m
Insulation class	IP66 / IP68
Conductor area cord	3 x 2.5 mm ²
Voltage	250 VAC
Current	20 A
Weight	220 g (1 m) / 430 g (2 m)



WALL SOCKET

Dimensions (W x D x H) in mm	75 x 65 x 210
Insulation class	IP55
Voltage	max. 250 VAC
Current	16 A
Weight	320 g



STAINLESS STEEL SHORE POWER INLET

Dimension	Ø 90 mm
Length of connection cord	40 cm
Insulation class	IP56/ IP68 (cord)
Conductor area cord	3 x 2.5 mm ²
Voltage	max. 250 VAC
Current	16 A



ELECTRICAL CABINET

Dimensions (W x D x H) in mm	80 x 100 x 260
Insulation class	IP55
Voltage	max. 250 VAC
Current	16 A
Weight	560 g

PLUGS (STANDARD WITH CABLE SETS)

Article Number	50214688	50214689
TECHNICAL SPECIFICATIONS		
For use up to	16 A / 250 VAC (max.)	32 A / 250 VAC (max.)
IP Rating	IP56	IP56
Certification	CE	CE



**LAND POWER CORD SET
ADAPTOR CORD 16 A / 250 VAC SCHUKO TO CEE**

Article Number	50214720
DIMENSIONS & WEIGHT	
Weight	2.1 kg
Length	15 m
Dimension	Ø 8.5 mm
GENERAL	
Temperature range	-40 °C up to 80 °C
Insulation class	IP56
Conductor area	3 x 1.5 mm ²
Voltage	250 VAC
Current	10 A

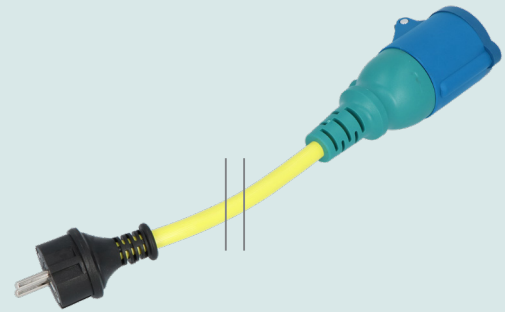

16 A POLYAMIDE VERSION

16 A STAINLESS STEEL VERSION

32 A STAINLESS STEEL VERSION

Article Number	50214680	50214684	50214685
TECHNICAL SPECIFICATIONS			
For use up to	16 A / 250 VAC (max.)	16 A / 250 VAC (max.)	32 A / 250 VAC (max.)
IP Rating	IP56	IP56	IP56
Certification	CE	CE	CE
Dimension	Ø 87 mm	Ø 87 mm	Ø 105 mm
Weight	230 g	340 g	650 g

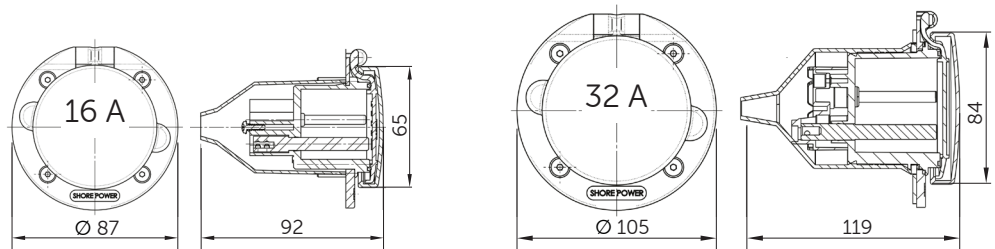

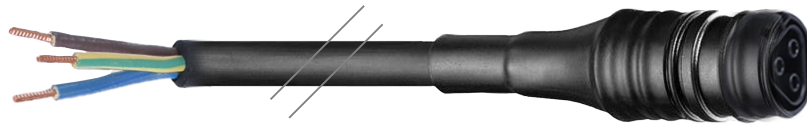

WHISPERPOWER LAND POWER CONNECT 230 VAC 50 Hz

Article Number	Model
50217140	WP-QC Mains Power Cord, FEMALE Crimp Socket • Free Ends, 1 m, Rubber 60°C Black - 3-wire L+N+PE
50217141	WP-QC Mains Power Cord, MALE Crimp Socket • Free Ends, 1 m, Rubber 60°C Black - 3-wire L+N+PE

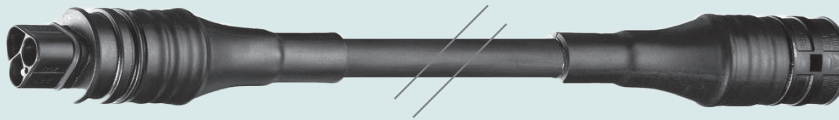

WHISPERPOWER LAND POWER CONNECT 230 VAC 50 Hz

Article Number	Model
50217150	WP-QC - Extension cable female - male • 3 pole - 1.5 mm ² 1 m Black Rubber 60°C - 3-wire L+N+PE
50217151	WP-QC - Extension cable female - male • 3 pole - 1.5 mm ² 6 m Black Rubber 60°C
50217153	WP-QC - Extension cable female - male • 3 pole - 1.5 mm ² 10 m Black Rubber 60°C
50217154	WP-QC - Extension cable female - male • 3 pole - 1.5 mm ² 2 m Black PVC 70°C

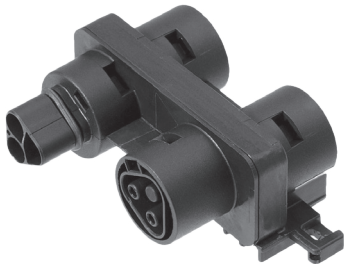

Article Number: 50217161



Article Number: 50217164



Article Number: 50217165

WHISPERPOWER LAND POWER CONNECT 230 VAC 50 Hz

Article Number	Model
50217161	WP-QC Distribution block, 1 input (Female) and 3 outputs (Male) 3 pole 250 VAC / 20 A - Black
50217164	WP-QC Inlet - Chassis mounting - Female Black • 3 pole 250 VAC / 20 A
50217165	WP-QC Inlet - Chassis mounting - Male Black • 3 pole 250 VAC / 20 A

Quick Connect unplugged



Quick Connect plugged



WhisperPower DC Power Distribution

The weakest link determines the safety and reliability of the system. That's in particular valid for DC systems of 12, 24 or 48 VDC. That is why WhisperPower supplies components and devices of the highest quality.

Lithium battery technology has pushed the bar even higher: high charge/ discharge currents require heavy duty, well dimensioned components.

System Links

All our DC devices are designed to link the various system components such as battery chargers, inverters, alternators, solar panels, windgenerators. Those devices have to be connected to one or more battery banks and the DC consumers. Our DC components incorporate safe switch-off technology. Sealed or open lead-acid batteries or lithium batteries have to be protected from overcharge or discharge. This exactly what the WhisperPower devices are designed for. Most of them can be adjusted to the operational situation.



Power Distribution Voltage Guard

[Go to Page 100](#)



Power Distribution Battery Links

[Go to Page 102](#)

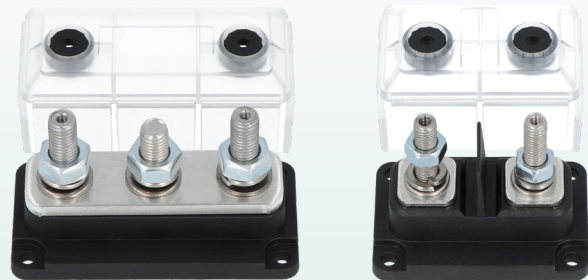

Power Distribution DC distribution systems

[Go to Page 104](#)



DC Modular
Remote Switches
500 A | 12/24/48 VDC

[Go to Page 112](#)



DC Power Distribution
Remote Switches
12/24/48 VDC

[Go to Page 114](#)

Power Distribution
DC Switches

[Go to Page 116](#)



Power Distribution
Battery Isolators

[Go to Page 120](#)



DC installations

Voltage Guard

The WhisperPower Voltage Guard protects the battery bank against accidental discharge. This is to make sure that the batteries are not damaged before the end of their normal lifespan. The Voltage Guard has to be installed in the DC connection between the battery and the DC consumers. The Voltage Guard is programmable and the desired upper and lower limits of the permissible voltage is easy to set up. Maximum current 200 A.



The WhisperPower Voltage Guard is an essential component of a well-equipped battery system ensuring a longer life span for your batteries. The voltage protection maintains your battery system in optimum condition and can also be used as an intelligent battery switch.

The WVG consists of a high current electronic switch capable of switching loads of up to 200 Amps. If the battery voltage drops below a previously set value the load will automatically disconnected.

The ON-and-OFF-values are set by the potentiometer on the front of the unit. When any of these set points are reached, a warning LED will light up and in addition an audible alarm will sound. This is to prevent the battery being discharged below the preset voltage.

Remote monitoring and operation is possible if the WVG is linked to the main panel. A built-in hysteresis allows for a short-term voltage drop caused by switching on a heavy load. The WVG has an extremely low consumption of only 4 mA in standby.



WVG-40

12 - 24 VDC 40 A

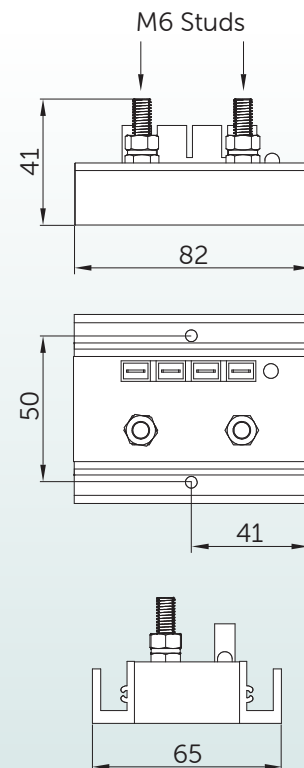

Voltage Guard 200

WVG-200

Article Number 60110200

TECHNICAL SPECIFICATIONS

Current (continuous/intermittent)	150 / 200 A
System voltage	12 / 24 VDC
Input voltage range	8 - 31 VDC
Dimensions (W x D x H) in mm	97 x 85 x 146
Weight	600 g
Lower limit battery voltage 12 VDC	9 - 12 VDC
Upper limit battery voltage 12 VDC	15.5 VDC
Lower limit battery voltage 24 VDC	18 - 24 VDC
Upper limit battery voltage 24 VDC	35 VDC
Warranty	5 years

WVG-200 Diagram

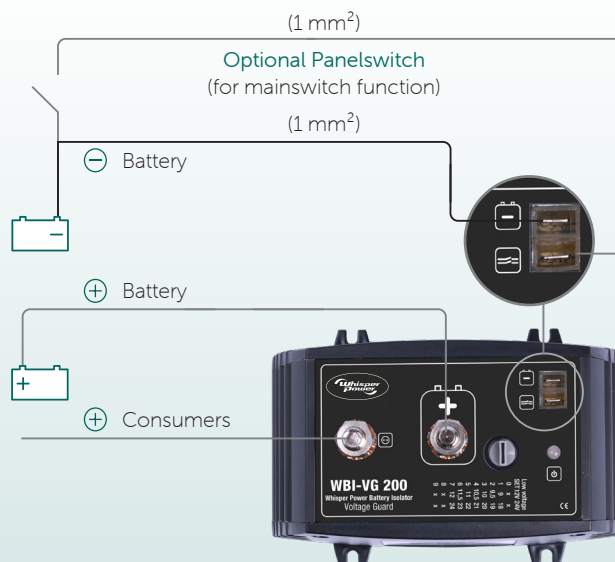

40 A

60110240



60 A

60110250

Voltage Guard Series

Article Number

60110240

60110250

TECHNICAL SPECIFICATIONS

Cable diameter	10 mm ²	15 mm ²
Automatic detection of 12 or 24 VDC system	8 - 20 VDC 12 VDC mode 20 - 35 VDC 24 VDC mode	8 - 20 VDC 12 VDC mode 20 - 35 VDC 24 VDC mode
Adjustable undervoltage programs	10	10
Overvoltage disconnect voltage	12 VDC mode 16 VDC 24 VDC mode 32 VDC	12 VDC mode 16 VDC 24 VDC mode 32 VDC
Maximum load / shutdown	approx 40 A - 45 A	approx 60 A - 65 A
Surge	120 A	120 A
Voltage drop	0.1 VDC at 40 A	0.1 VDC at 60 A
Current consumption	Output active: 4 mA Output active: 2 mA	Output active: 4 mA Output active: 2 mA
Shutdown at overload / short circuit	After 5 seconds (switch on again after 1 minute)	After 5 seconds (switch on again after 1 minute)
Voltage accuracy	2 %	2 %
Current accuracy	20 %	20 %
IP-code	IP66	IP66
Dimensions (W x D x H) in mm	82 x 41 x 65	82 x 41 x 65
Weight	185 g	185 g

Wiring diagram

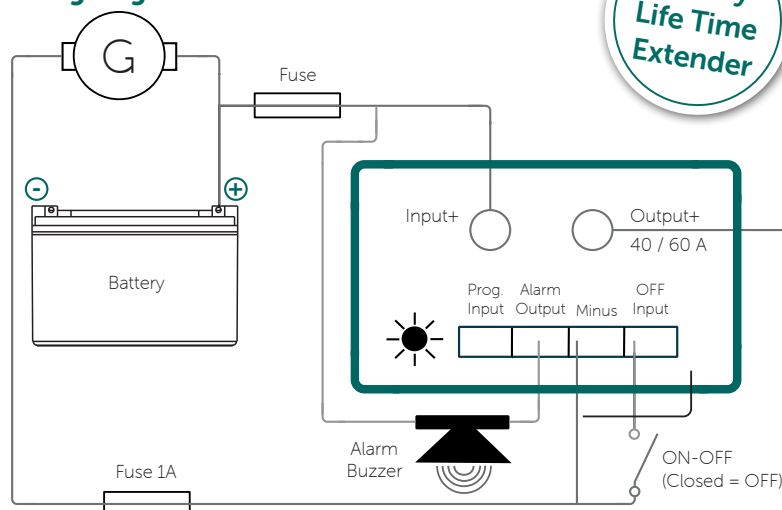

Battery Life Time Extender

The WhisperPower Voltage Guard is the best in its class for a well equipped battery system!



DC installations

Intelligent Battery Links



WhisperPower Battery Links are smart switch regulators that automatically connect two battery banks if the charge voltage rises above a certain value for at least five seconds. This means that the battery banks can be charged from the same source. To protect the battery banks they are separated from each other as soon as the voltage drops. There are four models available: the 100 A, 120 A, 140 A and the 160 A version.

This is a smart, independent and automatic device. For extra starting power there is a start assist function. With a simple push of a button the service battery bank is temporarily connected to the starter battery. The connection is terminated after 30 seconds. The WhisperPower Battery Link clearly indicates when the batteries are connected. If the LED is not lit, the relay is open. Whenever one of the batteries is being charged, the LED starts to blink slowly indicating a 30 seconds period until the relay closes to connect the batteries. Whilst the relay remains closed, the LED remains illuminated.

Features and Benefits

- Simultaneous charging of two batteries
- Intelligent battery monitoring function
- Safe connect algorithm
- Temporary additional power with start assist function
- Simultaneous charging of two batteries
- Simple to install, no programming required
- Compact and robust
- Automatic relay to connect battery banks
- Automatic isolation with voltage drop
- Remote control possible (optional)
- Connect battery banks in parallel for emergency start
- LED indicators

WhisperPower
microprocessor
controlled
Battery
Combiners



LED status



WBL Series

	WBL-100	WBL-120	WBL-140
Article Number	60110118	60110120	60110170
AUTOMATIC OPERATION			
Switch-on voltage (minimum)	> 13 VDC at 12 VDC / > 26 VDC for 24 VDC installations		
Connection delay	7 seconds	5 seconds	5 seconds
Switch-on voltage (maximum)	16 VDC at 12 VDC 32 VDC for 24 VDC installations	15 VDC at 12 VDC 30 VDC for 24 VDC installations	15 VDC at 12 VDC 30 VDC for 24 VDC installations
Disconnection voltage	12.75 VDC at 12 VDC / 25.5 VDC for 24 VDC installations		
DC-CONSUMPTION			
OFF-Mode (relay not powered)	1.5 mA	1.0 mA at 12 VDC 1.1 mA at 24 VDC	1.0 mA at 12 VDC 1.1 mA at 24 VDC
ON-Mode (inrush current)	360 mA at 12 VDC 160 mA at 24 VDC	0.5 A at 12 VDC 0.4 A at 24 VDC	0.5 A at 12 VDC 0.4 A at 24 VDC
ON-Mode (relay powered)	360 mA at 12 VDC 160 mA at 24 VDC	50 mA at 12 VDC 40 mA at 24 VDC	50 mA at 12 VDC 40 mA at 24 VDC
LED STATUS			
On	N/A	Relay connected	N/A
Flashing slowly (0.5 Hz)	N/A	Delay whilst connecting	N/A
Flashing fast (2.5 Hz)	N/A	Alarm: Relay not powered as voltage difference is too big in OFF-Mode (> 8 VDC) or due to voltage drop being too large in ON-Mode (0.5 VDC)	N/A
TECHNICAL SPECIFICATIONS			
Weight	94 g	125 g	125 g
Dimensions (W x D x H) in mm	46 x 46 x 80	46 x 46 x 80	46 x 46 x 80
Continuous capacity	100 A	120 A	140 A
Peak capacity /inrush current 10 sec.	180 A	180 A	180 A
Input voltage	8 - 35 VDC	9 - 35 VDC	8 - 35 VDC
Operating temperature	-20 up to 60 °C	-40 up to 65°C	-40 up to 65°C
Maximum voltage drop	0.5 VDC (Approx. 10 seconds delay during disconnection)		
Maximum allowable voltage difference	8 VDC	8 VDC	8 VDC
CONFORMITY			
CE	Yes	Yes	Yes

Example set up

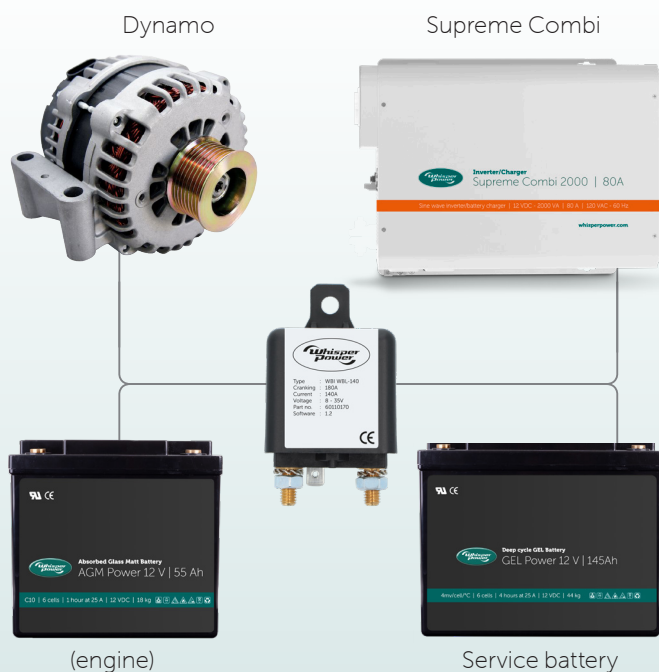

	WBL-160
Article Number	60110160
INPUT	
Smart battery switch	4 c 6
Nominal input voltage	12 / 24 VDC self detection
Input range no defects	7 - 32 VDC
OUTPUT	
Nominal output voltage	Equal to input voltage
Surge outgoing	480 A
Max. charge current 3 sec.	240 A
Continuous charging current	160 A
Continuous charging current at 40°C	160 A
GENERAL	
Consumption in Standby	± 2 mA
Consumption whilst charging 12 / 24 VDC	340 / 170 mA
Consumption whilst connecting 12 / 24 VDC	340 / 170 mA
Ambient operating temperature	-10 up to 40°C
Storage temperature	-25 up to 85°C
International Protection rating	IP66
Voltage accuracy	2 %
Switch-on voltage 12 / 24 VDC	13.2 / 26.4 VDC
Disconnection voltage 12 / 24 VDC	12.8 / 25.4 VDC
Accelerated disconnection voltage 12 / 24 VDC	11.8 / 23.6 VDC
Connection delay	5 seconds
Disconnection delay	60 seconds
Accelerated disconnection	4 seconds
PROTECTIONS	
Polarity	Yes
Voltage too low	Yes
Voltage too high	16 / 32 VDC
FEATURES	
Controlled microprocessor	Yes
Voltage too low	Yes
Voltage too high	Yes
Start assist	Yes
LED display	Yes
Output status	No
Input status	Yes
Remote shutdown	No
TECHNICAL SPECIFICATIONS	
Connection in / out	M8
Connections min. / status / remote	Faston 6.3 mm
Dimensions (W x D x H) in mm	108 x 72 x 58
Mounting holes	Dia 6 mm, 88.5 mm
Weight	500 g
Housing / colour	Polyurethane / Black

WhisperPower

Modular DC Distribution Compact & heavy duty range

With an increase in the use of offgrid electrical devices and systems inside vehicles, boats and land-based objects, AC appliances via the inverter, DC systems and accompanying batteries also need to be able to cope with these heavier loads. WhisperPower now also supplies turnkey "bespoke" DC distribution systems made up of high quality electrical components. These components can either be combined to form a system by the installer or, if required, be delivered by WhisperPower as a Plug and Play ready-made connection set.



Example of a pre-assembled DC distribution assembly, as a Plug and Play solution

We can
pre-fab the
DC distribution
system for you

DC Modular high current Busbars and Fuse holders

Due to the ever increasing complexity of electrical DC systems on board of vehicles or in stationary applications, there is a growing need for a uniform set of products that significantly improves the installation time and flexibility. The WhisperPower DC Modular product range offers a perfect solution for this. It contains a wide range of high current busbars, fuse holders and interconnection materials. Compared to more traditional and often incompatible DC distribution products, the DC Modular system offers many innovative features.

The DC Modular product range is also a perfect companion for WhisperPower battery monitoring devices.

All DC Modular products are equipped with stainless steel studs, washers and nuts for optimal corrosion resistance. Tin plated high purity copper busses provide maximum conductivity, reducing heat and improving efficiency. The base material used for the DC Modular products is made from a special fibre reinforced compound. This material offers excellent high temperature properties, good chemical resistance and high strength. This focus on the highest quality materials ensures long life in harsh environments. All DC Modular products are designed and assembled in The Netherlands.



Transparent poly carbonate cover with break-out side skirts at each side, for easy cable entry



The optional adapter plate allows a mixture of high- and low power cables to be connected to the same stud

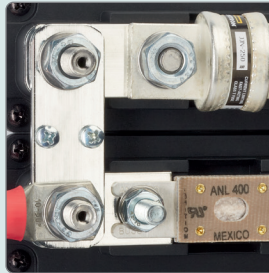

Multiple fuse holders and busbars can be connected to each other with the optional link plates



Smart terminal design allows dual mirrored cable lug connections

Easy in-system connection access due to top locked covers by convenient thumb screws

Special fiber reinforced base material offers excellent high temperature properties, good chemical resistance and high strength

Smart terminal design allows dual mirrored cable lug connections

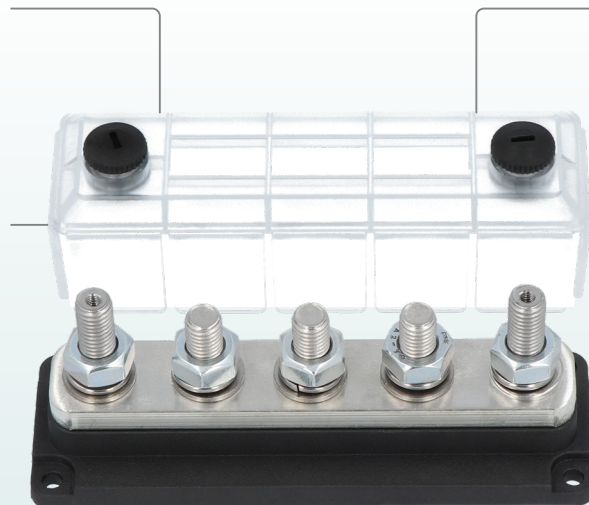

Top sides of transparent covers are equipped with recessed locations to properly add custom labels

Robust transparent covers with breakouts to allow wire access from any direction

Tin plated high purity copper busses provide maximum conductivity, reducing heat and improving efficiency

Stainless steel studs, nuts and washers for optimal corrosion resistance

DC Modular insulated studs

The DC Modular single and dual insulated studs are ideal parts to extend cables, add power taps or form termination end-points.

The solid and compact design, as well as the possibility to link these up with other DC Modular family members, make these products the best choice for all professional DC power systems. The insulated studs are available with M8 or M10 stud sizes.

Features:

- Stainless steel studs, nuts and washers for optimal corrosion resistance
- Special fiber reinforced base material offers excellent high temperature properties, good chemical resistance and high strength
- Unique grid optimized footprints allow space saving arrangements of multiple products
- Common interconnection heights for easy combining of multiple products using link plates
- Robust transparent covers with breakouts to allow wire access from any direction
- Top sides of transparent covers are equipped with recessed locations to properly add custom labels (Dual insulated stud only)
- Smart terminal design allows dual mirrored cable lug connections
- Easy in-system connection access due to top locked covers



Single Stud | 1x M8/M10





SINGLE STUD
1x M8



SINGLE STUD
1x M10

Article Number	50212005	50212006
TECHNICAL SPECIFICATIONS		
Grid size	1 x 1	1 x 1
Dimensions (W x D x H) in mm	50 x 50 x 64.5	50 x 50 x 64.5
Fuse range	N/A	N/A
Max. Voltage *)	50 VDC	50 VDC
Connection studs	M8	M10
Size A / Size B	38 / 38 mm	38 / 38 mm

Busbar Dimensions

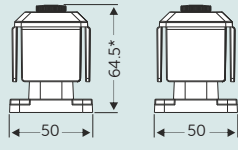

*) Total height without cover is 56.3 mm

Dual Stud | 2x M8/M10





DUAL STUD
2x M8



DUAL STUD
2x M10

Article Number	50212007	50212008
TECHNICAL SPECIFICATIONS		
Grid size	1 x 1.5	1 x 5
Dimensions (W x D x H) in mm	50 x 50 x 64.5	50 x 50 x 64.5
Fuse range	N/A	N/A
Max. Voltage *)	50 VDC	50 VDC
Connection studs	M8	M10
Size A / Size B	38 / 63 mm	38 / 63 mm

Busbar Dimensions

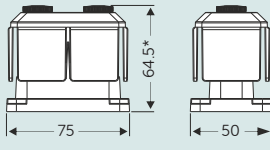

*) Total height without cover is 56.3 mm



DC Modular high current busbars

The DC Modular high current busbars are used to distribute high DC currents to a number of connected cables, or other DC Modular family members. The solid and compact design, as well as the possibility to link up multiple busbars on a fixed grid, make these products the best choice for all professional DC power systems. The high current busbars are available with M8 or M10 stud sizes.



Features:

- Stainless steel studs, nuts and washers for optimal corrosion resistance
- Tin plated high purity copper busses provide maximum conductivity, reducing heat and improving efficiency
- Special fiber reinforced base material offers excellent high temperature properties, good chemical resistance and high strength
- Unique grid optimized footprints allow space saving arrangements of multiple products
- Common interconnection heights for easy combining of multiple products using link plates
- Robust transparent covers with breakouts to allow wire access from any direction
- Smart terminal design allows dual mirrored cable lug connections
- Easy in-system connection access due to top locked covers

3 Stud | 3x M8/M10

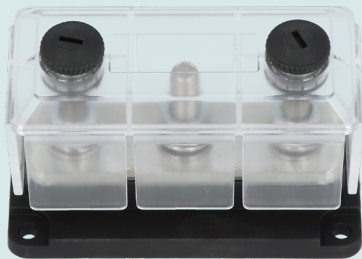

3 STUD
3x M8

3 STUD
3x M10

50212009

50212010

1 x 2

1 x 2

50 x 100 x 64.5

50 x 100 x 64.5

600 A

600 A

50 VDC

50 VDC

M8

M10

38 / 88 mm

38 / 88 mm

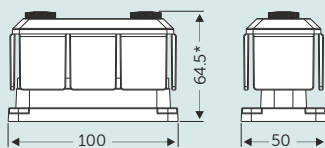

*1) Total height without cover is 56.3 mm

5 Stud | 5x M8/M10



5 STUD
5x M8

5 STUD
5x M10

50212011

50212012

1 x 3

1 x 3

50 x 100 x 64.5

50 x 100 x 64.5

600 A

600 A

50 VDC

50 VDC

M8

M10

38 / 138 mm

38 / 138 mm

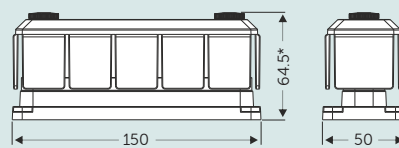

*1) Total height without cover is 56.3 mm

*1) Higher voltages may require additional safety measures

DC Modular fuse holders

A wide range of fuse holders are available in the DC Modular lineup, covering fuse Amp ratings from 35 A up to 600 A. Fuse holders are offered for the Mega®, ANL and Class-T type of fuses, providing solutions for a wide range of applications. The solid and compact design, as well as the possibility to link up multiple fuse holders on a fixed grid, make these products the best choice for all professional DC power systems.



MEGA 300 A | M8 + suitable fuses

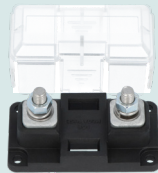
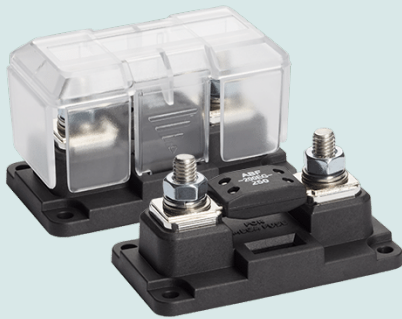

Fuse Holder Series

MEGA 300 A | M8
COMPACT SERIES

Article Number	50212013
TECHNICAL SPECIFICATIONS	
Grid size	1 x 1.78
Dimensions (W x D x H) in mm	50 x 89 x 53
Fuse range	40 - 300 A
Max. Voltage *)	50 VDC
Connection studs	M8
Size A / Size B	38 / 77 mm

Fuse Holder Dimensions

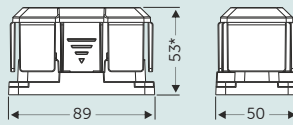

*) Total height without cover is 43.5 mm

FUSE MEGA SERIES



Art.Nr.	Model
50212023	Mega 100 A 58 VDC M8
50212024	Mega 150 A 58 VDC M8
50212025	Mega 200 A 58 VDC M8
50212026	Mega 300 A 58 VDC M8
50212044	Mega 40 A 32 VDC M8
50212027	Mega 80 A 32 VDC M8
50212028	Mega 100 A 32 VDC M8
50212029	Mega 150 A 32 VDC M8
50212030	Mega 200 A 32 VDC M8
50212032	Mega 300 A 32 VDC M8
50212046	Mega 400 A 32 VDC M8

ANL 300 A | M8/M10 + suitable fuses

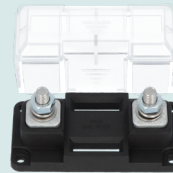
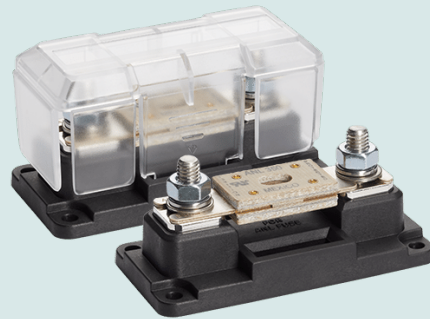

ANL 300 A | M8 *)
COMPACT SERIES

ANL 300 A | M10
COMPACT SERIES

Article Number	50212014	50212015
TECHNICAL SPECIFICATIONS		
Grid size	1 x 2	1 x 2
Dimensions (W x D x H) in mm	50 x 100 x 53	50 x 100 x 53
Fuse range	35 - 300 A	35 - 300 A
Max. Voltage *)	50 VDC	50 VDC
Connection studs	M8	M10
Size A / Size B	38 / 88 mm	38 / 88 mm

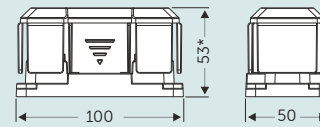

*) Total height without cover is 43.5 mm

FUSE ANL SERIES



Art.Nr.	Model
50212041	ANL 35 A 48 VDC M10
50212042	ANL 63 A 48 VDC M10
50212033	ANL 100 A 48 VDC M10
50212034	ANL 150 A 48 VDC M10
50212043	ANL 200 A 48 VDC M10
50212035	ANL 300 A 48 VDC M10



Features:

- Stainless steel studs, nuts and washers for optimal corrosion resistance
- Tin plated high purity copper busses provide maximum conductivity, reducing heat and improving efficiency
- Special fiber reinforced base material offers excellent high temperature properties, good chemical resistance and high strength

- Unique grid optimized footprints allow space saving arrangements of multiple products
- Common interconnection heights for easy combining of multiple products using link plates (except Mega and ANL (300 A) fuse holders)
- Robust transparent covers with breakouts to allow wire access from any direction
- Smart terminal design allows dual mirrored cable lug connections
- Easy in-system connection access due to top locked covers (except Mega and ANL (300 A) fuse holders)

**ANL 600 A | M10
+ suitable fuses**

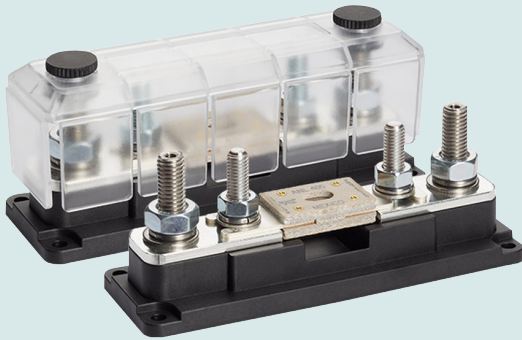

**ANL 600 A | M10
HEAVY DUTY SERIES**

50212017

1 x 3

50 x 150 x 64.5

35 - 600 A

50 VDC

M10

38 / 138 mm

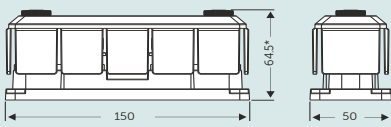

*) Total height without cover is 56.3 mm

FUSE ANL SERIES

Art.Nr.	Model
50212041	ANL 35 A 48 VDC M10
50212042	ANL 63 A 48 VDC M10
50212033	ANL 100 A 48 VDC M10
50212034	ANL 150 A 48 VDC M10
50212043	ANL 200 A 48 VDC M10
50212035	ANL 300 A 48 VDC M10
50212036	ANL 400 A 48 VDC M10



**Class-T 400/600 A | M10
+ suitable fuses**



**CLASS-T 400 A | M10
HEAVY DUTY SERIES**

50212018

1 x 3

50 x 150 x 64.5

225 - 400 A

50 VDC

M10

38 / 138 mm

**CLASS-T 600 A | M10
HEAVY DUTY SERIES**

50212019

1 x 3

50 x 150 x 64.5

450 - 600 A

50 VDC

M10

38 / 138 mm

*) Higher voltages may require additional safety measures

**) For M8 ANL type fuses

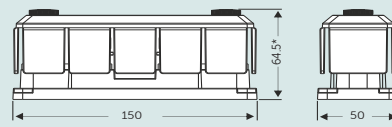

*) Total height without cover is 56.3 mm

**FUSE CLASS-T SERIES
SUITABLE FOR ANL 400 A**

Art. Nr.	Model
50212037	Class-T 225 A M10
50212047	Class-T 300 A M10
50212038	Class-T 400 A M10

**FUSE CLASS-T SERIES
SUITABLE FOR ANL 600 A**

Art. Nr.	Model
50212039	Class-T 450 A M12
50212040	Class-T 600 A M12



DC Modular accessories



Link / Adapter Plate Series

	41 mm (set of 2) Max. 600 A	50 mm (set of 2) Max. 600 A	46 mm (set of 2) Max. 600 A
Article Number *)	50212020	50212021	50212022
TECHNICAL SPECIFICATIONS			
Maximum Current **)	600 A	600 A	600 A
Dimensions (L x W)	63 x 25 mm	75 x 25 mm	46 x 25 mm
Accepts stud size	M8 + M10	M8 + M10	M8 + M10

*) Not compatible with "Mega" and "ANL (300 A)" Fuse holders
 **) Current capacity can be doubled by stacking two Link Plates (after removal of M4 screws)

Link / Adapter Plate Dimensions

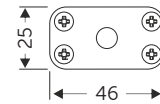
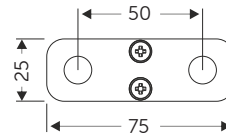
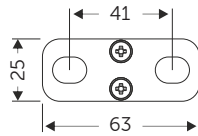

Link / Adapter Plate Connect examples

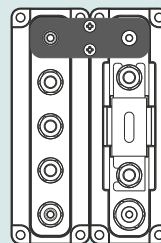
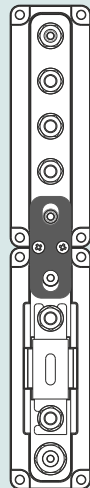
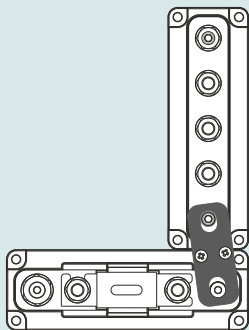

For converting an M8 or M10 stud to 4xM4 fork/ring terminals

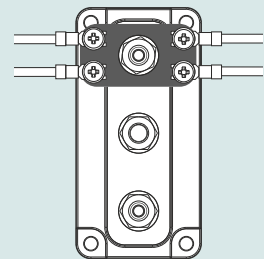

FOR LINKING TO AND FROM:	
BUSBARS	
Single Stud 1x M8	50212005
Single Stud 1x M10	50212006
Dual Stud 2x M8	50212007
Dual Stud 2x M10	50212008
3 Stud 3x M8	50212009
3 Stud 3x M10	50212010
5 Stud 5x M8	50212011
5 Stud 5x M10	50212012
FUSEHOLDERS	
ANL 600 A M8	50212016
ANL 600 A M10	50212017
Class-T 400 A M10	50212018
Class-T 600 A M10	50212019

FOR LINKING TO AND FROM:	
BUSBARS	
Dual Stud 2x M8	50212007
Dual Stud 2x M10	50212008
3 Stud 3x M8	50212009
3 Stud 3x M10	50212010
5 Stud 5x M8	50212011
5 Stud 5x M10	50212012
FUSEHOLDERS	
ANL 600 A M8	50212016
ANL 600 A M10	50212017
Class-T 400 A M10	50212018
Class-T 600 A M10	50212019

FOR LINKING TO AND FROM:	
BUSBARS	
Single Stud 1x M8	50212005
Single Stud 1x M10	50212006
Dual Stud 2x M8	50212007
Dual Stud 2x M10	50212008
3 Stud 3x M8	50212009
3 Stud 3x M10	50212010
5 Stud 5x M8	50212011
5 Stud 5x M10	50212012
FUSEHOLDERS	
ANL 600 A M8	50212016
ANL 600 A M10	50212017
Class-T 400 A M10	50212018
Class-T 600 A M10	50212019



Due to the common interconnection heights, smart space saving arrangements of multiple DC Modular products can be made by linking these together using the optional Link Plates. We have two Link Plate sizes available between which we are able to create all possible combinations. Both Link Plates are compatible with M8 and M10 studs. Additionally, we have equipped the Link Plates with two M4 screws to provide convenient connection points for smaller cables. Should this be required, we also offer an Adapter Plate which allows a mixture of high and low power cables to be connected to the same stud. The Adapter Plate can be used on M8 and M10 studs and offers four connection points for smaller cables.

Features:

- Tin plated high purity copper busses provide maximum conductivity, reducing heat and improving efficiency
- Stainless steel M4 screws and washers provide convenient connection points for smaller cables
- Compatible with M8 and M10 studs

Link Bar Series

LINK BARS

Art. Nr.	Model
50212084	2 Holes (50.5 mm pitch)
50212085	3 Holes (50.5 mm pitch)
50212086	4 Holes (50.5 mm pitch)
50212087	5 Holes (50.5 mm pitch)
50212088	6 Holes (50.5 mm pitch)
50212091	8 Holes (50.5 mm pitch)

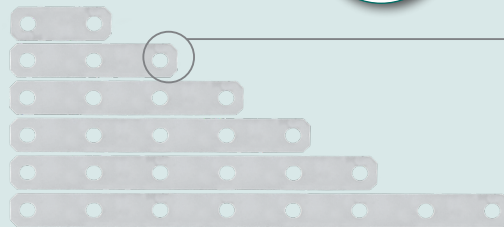

Link Bar Connect examples

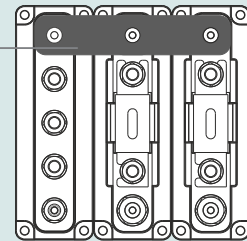

Link Plate Series

LINK PLATES

Art. Nr.	Model
50212080	4 Top - 4 Down
50212090	5 Top - 5 Down
50212082	6 Top - 6 Down

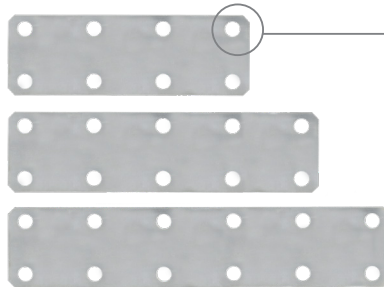

Link Plate Connect examples

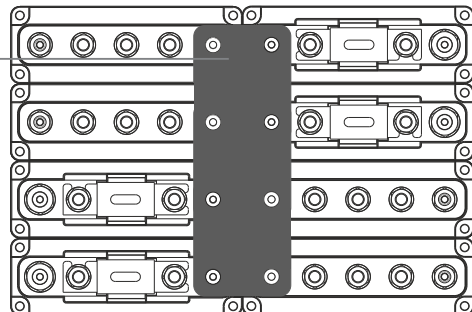

Base Plate Series

BASE PLATES

Art. Nr.	Model
50212081	4 Top - 4 Down
50212083	6 Top - 6 Down
50212089	8 Top - 8 Down
50211363	Taprite Bolt Torx M4 x 8

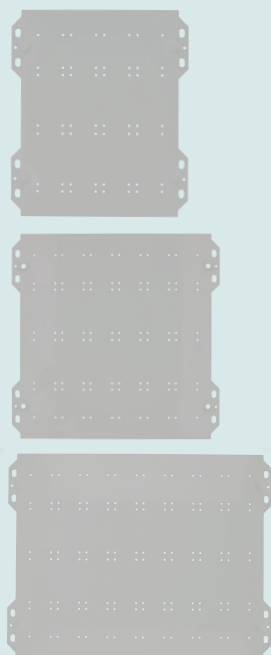

DC Distribution board Example

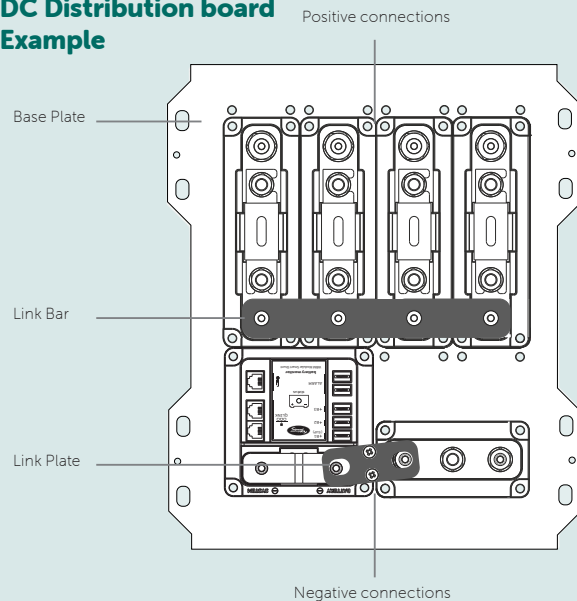

DC installations

Remote Battery Switch (500A)

The DC Modular Remote Battery Switch (the Switch) is a smart high current magnetic latching contactor, that can handle continuous DC currents of up to 500 Amps. The Switch can easily be installed in an engine room or battery compartment, while being controlled from a more convenient location by a small panel mounted Switch. But the Switch can for instance also be controlled by a battery monitor or Lithium battery, as a discharge / overcharge protection.

Besides controlling the Switch remotely, buttons positioned at the top also provide a way to open or close the main contact locally. For external control, the Switch is equipped with a 5 wire interface cable. It can be configured to accept two wire or single wire ON-OFF commands for optimal flexibility.

The Switch is a magnetic latching relay, which means that there is no current draw from the battery when the contact is closed. This is a great benefit compared to regular relays which do require a (sometimes significant-) hold current to keep the contact closed.

Another benefit of the Switch are the built in protections. It is protected against high / low supply voltage and high temperature. On top of this, there is a smart function available to automatically fix light to medium contact weldings. And finally, the Switch is also ignition protected according to ISO8846.

The Switch can be part of a very compact DC distribution system (see page 104). The Switch footprint is around 50 % smaller compared to some competing products, which is perfect for space constrained installations.

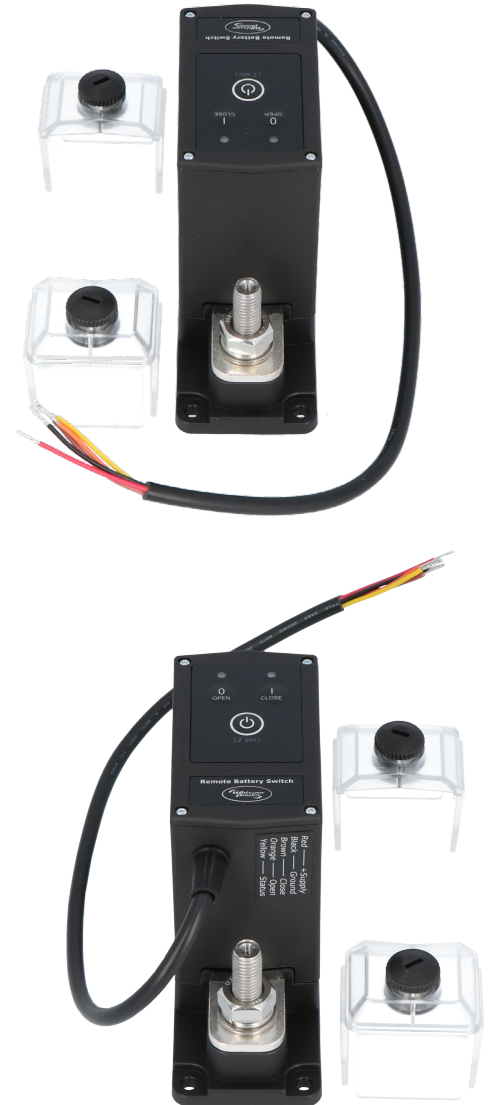

Dimensions

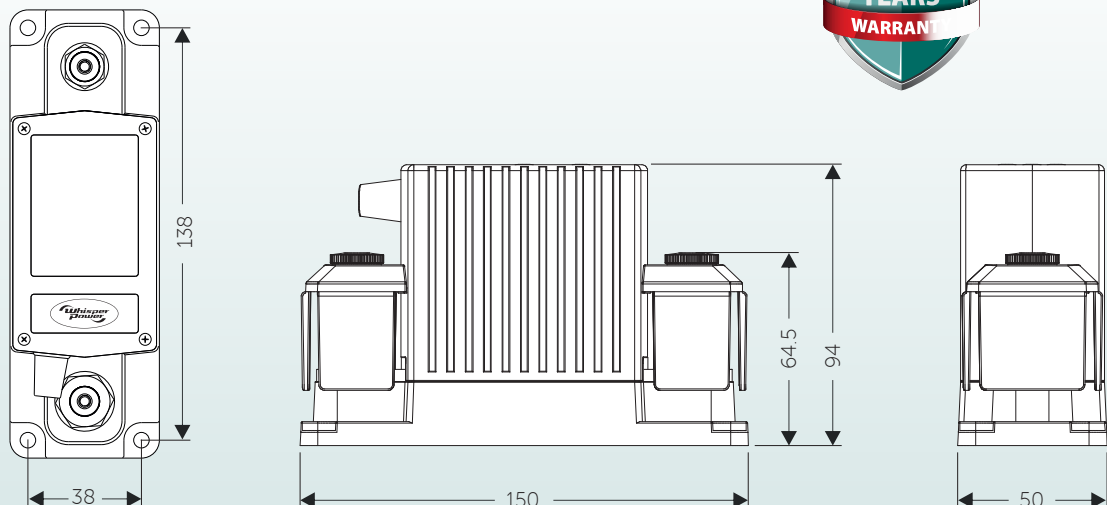



DC Modular Series

	REMOTE BATTERY SWITCH 12 VDC 500 A	REMOTE BATTERY SWITCH 24 VDC 500 A	REMOTE BATTERY SWITCH 48 VDC 350 A	BATTERY PROTECT RELAY 12 VDC 500 A	BATTERY PROTECT RELAY 24 VDC 500 A	BATTERY PROTECT RELAY 48 VDC 350 A
--	---	---	---	---	---	---

Article Number	50214733	50214734	50214718	50214737	50214739	50214740
----------------	----------	----------	----------	----------	----------	----------

TECHNICAL SPECIFICATIONS

Rated voltage	60 VDC	60 VDC	60 VDC	60 VDC	60 VDC	60 VDC
Nominal current	500 A	500 A	350 A	500 A	500 A	350 A
Cranking current (1 min.)	1000 A	1000 A	1000 A	1000 A	1000 A	1000 A

Nominal make / break current	500 A (0 - 34 VDC) / 350 A (35 - 60 VDC)			500 A (0 - 34 VDC) / 350 A (35 - 60 VDC)		
------------------------------	--	--	--	--	--	--

Peak make / break current	1600 A (0 - 34 VDC) / 1200 A (35 - 60 VDC)			1600 A (0 - 34 VDC) / 1200 A (35 - 60 VDC)		
---------------------------	--	--	--	--	--	--

CONTROL CIRCUIT (ELECTRICAL)

Coil / supply voltage (+ VDC)	7.5 - 17 VDC	15 - 34 VDC	34 - 68 VDC	7.5 - 17 VDC	15 - 34 VDC	34 - 68 VDC
-------------------------------	--------------	-------------	-------------	--------------	-------------	-------------

Coil / supply current (idle state) *)	< 100 µA	< 100 µA	< 100 µA	< 100 µA	< 100 µA	< 100 µA
---------------------------------------	----------	----------	----------	----------	----------	----------

Coil / supply current (state change) *)	< 6 A	< 3 A	< 1.5 A	< 6 A	< 3 A	< 1.5 A
---	-------	-------	---------	-------	-------	---------

GENERAL

Remote control	By control wires	By control wires	By control wires	By control wires	By control wires	By control wires
----------------	------------------	------------------	------------------	------------------	------------------	------------------

Local control **)	Top side buttons (ON/Standby, Close contact, Open contact)			ON/Standby, Open and Close contact, Override mode		
-------------------	--	--	--	---	--	--

Indicators	Top side LEDs for Contact open, Contact closed, Error and Setup			Contact open/close, Undervoltage disconnect, Override mode, Error and Setup		
------------	---	--	--	---	--	--

Mechanical life	100000 cycles	100000 cycles	100000 cycles	100000 cycles	100000 cycles	100000 cycles
-----------------	---------------	---------------	---------------	---------------	---------------	---------------

Electrical life	10000 cycles	10000 cycles	10000 cycles	10000 cycles	10000 cycles	10000 cycles
-----------------	--------------	--------------	--------------	--------------	--------------	--------------

Operating temperature range	-20 up to 60°C	-20 up to 60°C	-20 up to 60°C	-20 up to 60°C	-20 up to 60°C	-20 up to 60°C
-----------------------------	----------------	----------------	----------------	----------------	----------------	----------------

Connection stud size	M10	M10	M10	M10	M10	M10
----------------------	-----	-----	-----	-----	-----	-----

DC Modular grid size	1 x 3	1 x 3	1 x 3	1 x 3	1 x 3	1 x 3
----------------------	-------	-------	-------	-------	-------	-------

Protection class	IP65	IP65	IP65	IP65	IP65	IP65
------------------	------	------	------	------	------	------

Dimensions (W x D x H) in mm	50 x 94 x 150	50 x 94 x 150	50 x 94 x 150	50 x 94 x 150	50 x 94 x 150	50 x 94 x 150
------------------------------	---------------	---------------	---------------	---------------	---------------	---------------

Weight	800 g	800 g	800 g	800 g	800 g	800 g
--------	-------	-------	-------	-------	-------	-------

Standards	CE certified (EMC Directives UNECE Regulation 10 and 2014/30/EU, Low voltage Directive 2014/35/EU, RoHS Directive 2011/65/EU and Ignition protection standard ISO 8846)					
-----------	---	--	--	--	--	--

*) Due to the magnetic latch construction, the DCM-RBS draws virtually no current in the ON or OFF state.

A current draw only exists shortly (500 ms max.) when changing the state of the contact.

**) Using the top side buttons, one can manually override the switch state as commanded through the control wires.

A dedicated 'On / Standby' button also allows the user to put the DCM-RBS in a standby mode with open contact.

In this mode any command from the control wires and/or manual override buttons are ignored.

WP-Panel Switch Indicator



WP-Panel Switch
Art. Nr. 50214730

Dimensions

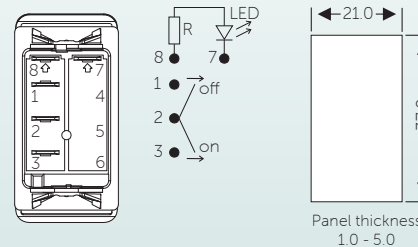
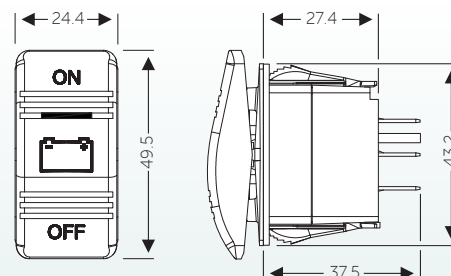

DC installations

Remote battery switches - 500 A

These are robust, quality products engineered for harsh environments and built to last. The WP-ML is a heavy duty remote battery switch. It features a 500 Amp magnetic latching (bi-stable) switch providing high-amp switching under load, which can be operated both manually or remotely.



- 500 Amp continuous load
- Bi-stable or auto magnetic latching, very low consumption at no-load mode
- Manual override knob provides an added level of safety allowing control with or without power and LOCK- OFF option for service / maintenance
- Remote LED indicator for switch state possible (optional)
- Tin-plated M10 copper studs for maximum conduction and corrosion resistance
- Multiple cable terminals, 22 mm thread
- Silver alloy contacts provide high reliability for switching live loads
- Optional Contura Switch to operate the Latch Relay
- IP66 protection rating



Included on the ML-RBS



Included on the ML-ACR





ML-RBS REMOTE BATTERY SWITCH 12 VDC ML-RBS REMOTE BATTERY SWITCH 24 VDC ML-ACR CHARGING RELAY 12 VDC ML-ACR CHARGING RELAY 24 VDC

WP-ML series

Article Number	50214731	50214732	50214735	50214736
TECHNICAL SPECIFICATIONS				
Product type	12 VDC remote magnetic battery switch	24 VDC remote magnetic battery switch	12 VDC magnetic latch charger relay	24 VDC magnetic latch charger relay
Switching / Circuit type	ON-OFF bi-stable	ON-OFF bi-stable	bi-stable ACR	bi-stable ACR
INPUT				
Number of batteries	1	1	2	2
Number of switching positions	2	2	2	2
Primary manual operation	Locked ON-OFF	Locked ON-OFF	Locked ON-OFF	Locked ON-OFF
I 10 inrush current 10 sec.	2500 A	2500 A	2500 A	2500 A
I 60 inrush current 1 min.	1100 A	1100 A	1100 A	1100 A
I 300 C interrupted 5 min.	700 A	700 A	700 A	700 A
I C continuously	500 A	500 A	500 A	500 A
Maximum operating voltage	32 VDC	32 VDC	32 VDC	32 VDC
Operating circuit voltage	10.1 - 16.5 VDC	20.2 - 32.9 VDC	10.1 - 16.5 VDC	20.2 - 32.9 VDC
Consumption in Standby	0 mA	0 mA	< 40 mA	< 40 mA
Consumption during charging	7 A	4 A	<7 A	<7 A
Remote control during switching	100 mA	100 mA	100 mA	100 mA
Battery banks automatically combined when voltage levels go above:	-	-	13.5 VDC for 30 seconds 13.0 VDC for 90 seconds	27 VDC for 30 seconds 26 VDC for 90 seconds
Battery banks automatically isolated when voltage levels are:	-	-	<ul style="list-style-type: none"> below 9.6 VDC (shut down low voltage) below 12.35 VDC for 10 seconds below 12.37 VDC for 30 seconds above 16.2 VDC (shut down high voltage) 	<ul style="list-style-type: none"> below 19.2 VDC (shut down low voltage) below 24.7 VDC for 10 seconds below 25.5 VDC for 30 seconds above 32.4 VDC (shut down high voltage)
GENERAL				
Ambient operating temperature	-20 up to 40°C	-20 up to 40°C	-20 up to 40°C	-20 up to 40°C
Storage temperature	-25 up to 85°C	-25 up to 85°C	-25 up to 85°C	-25 up to 85°C
Relative humidity in use	95 %, non-condensing	95 %, non-condensing	95 %, non-condensing	95 %, non-condensing
Number of switching cycles (with load)	100.000 cycles	100.000 cycles	100.000 cycles	100.000 cycles
MECHANICAL SPECIFICATIONS				
Thread connections	M10 (3/8"-16)	M10 (3/8"-16)	M10 (3/8"-16)	M10 (3/8"-16)
Length threaded stud	23 mm	23 mm	23 mm	23 mm
Maximum torque	15.5 Nm	15.5 Nm	15.5 Nm	15.5 Nm
Material threaded stud	Tin plated copper	Tin plated copper	Tin plated copper	Tin plated copper
Dimensions (W x D x H) in mm	95 x 52 x 139	95 x 52 x 139	95 x 52 x 139	95 x 52 x 139
Weight	800 g	800 g	800 g	800 g
Mounting diameter behind panel	114.3 x 76.2 mm	114.3 x 76.2 mm	114.3 x 76.2 mm	114.3 x 76.2 mm
Connection screws	4 mm	4 mm	4 mm	4 mm
International Protection rating	IP66	IP66	IP66	IP66
Housing colour	RAL9011 graphite black	RAL9011 graphite black	RAL9011 graphite black	RAL9011 graphite black
Cable opening	28.4 mm	28.4 mm	28.4 mm	28.4 mm
Ignition protection	SAE J1171	SAE J1171	SAE J1171	SAE J1171
Certification	CE, ISO 8846	CE, ISO 8846	CE, ISO 8846	CE, ISO 8846

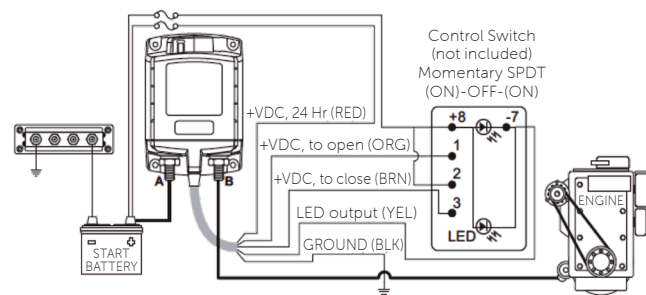
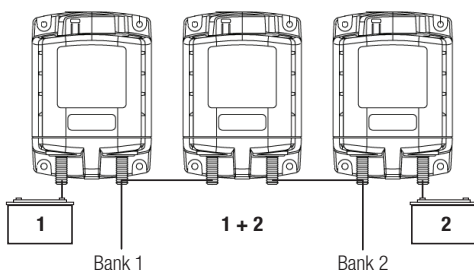

DC installations - switches

Robust and reliable switches-compact series

WhisperPower's philosophy is simple and clear: every single part of the electrical system must be robust and reliable. It is vital from the perspective of safety that all parts and components related to the battery comply with this principle.

From the perspective of safety on board it is vital that all parts and components related to the battery comply with this principle. We guarantee a safe and secure connection from your batteries - from starter batteries to large Lithium battery banks, because we have the right components for your system requirements.

Components for DC installations:

- Remote-controlled battery switches see page 112/114
- Intelligent battery switches see page 116
- Heavy duty manual battery switches see page 118
- Battery isolators see page 120

DC installations - switches

WP Compact - 300 A

Designed for battery banks of 12, 24 or 48 VDC, manually operated COMPACT series DC Switches are the best choice when it comes to connecting or disconnecting DC devices to / from a battery bank.



Features and Benefits

- Robust and compact design
- Tin-plated copper studs for maximum conduction and corrosion resistance
- Multiple cable terminals, 22 mm thread
- One-piece terminal prevents parts loosening
- Multiple cable input enables front or built-in panel mounting
- Circuit identification labels included
- CE marked
- UL certified in accordance with UL 1701 (power switches)
- ABYC compliant
- Conforms to UL 1500 SAE J 1171 external ignition protection requirements
- IP66 protection rating



WP-Compact series

	DC SWITCH 300 A SINGLE CIRCUIT	DC SWITCH 300 A DUAL CIRCUIT	DC SWITCH 300 A DUAL CIRCUIT + COMB.
--	-----------------------------------	---------------------------------	---

Article Number	50214701	50214702	50214703
----------------	----------	----------	----------

TECHNICAL SPECIFICATIONS

Product type	Hand operated battery switch	Hand operated battery switch	Hand operated battery switch
Switching	ON-OFF	Selection	Selection + Combination
INPUT			
Number of batteries	1	2	2
Number of switching positions	2	4	3
Combine batteries	-	Yes	Yes
I 10 inrush current 10 sec.	1500 A	1500 A	1500 A
I 60 inrush current 1 min.	775 A	775 A	775 A
I 300 C interrupted 5 min.	500 A	500 A	500 A
I C continuously	300 A	300 A	300 A
Maximum operating voltage	48 VDC	32 VDC	32 VDC

GENERAL

Ambient operating temperature	-20 up to 40°C	-20 up to 40°C	-20 up to 40°C
Storage temperature	-25 up to 85°C	-25 up to 85°C	-25 up to 85°C
Relative humidity in use	95 %, non-condensing	95 %, non-condensing	95 %, non-condensing

MECHANICAL SPECIFICATIONS

Thread connections	M10 (3/8"-16)	M10 (3/8"-16)	M10 (3/8"-16)
Length threaded stud	22 mm	23 mm	24 mm
Maximum torque	13.6 Nm	13.6 Nm	13.6 Nm
Material threaded stud	Tin plated copper	Tin plated copper	Tin plated copper
Dimensions (W x D x H) in mm	72 x 78 x 72	72 x 78 x 72	72 x 78 x 72
Weight	280 g	280 g	280 g
Borehole spacings	55 mm	56 mm	57 mm
Mounting diameter behind panel	59 mm	60 mm	61 mm
Connection screws	10 mm	11 mm	12 mm
International Protection rating	IP66	IP67	IP68
Housing colour	RAL9011 graphite black	RAL9011 graphite black	RAL9011 graphite black
Cable opening	28 mm	29 mm	30 mm
Ignition protection	UL 1500 SAE J1171	UL 1500 SAE J1172	UL 1500 SAE J1173
Certification	CE, ISO 8846	CE, ISO 8847	CE, ISO 8848

Installation Drawing

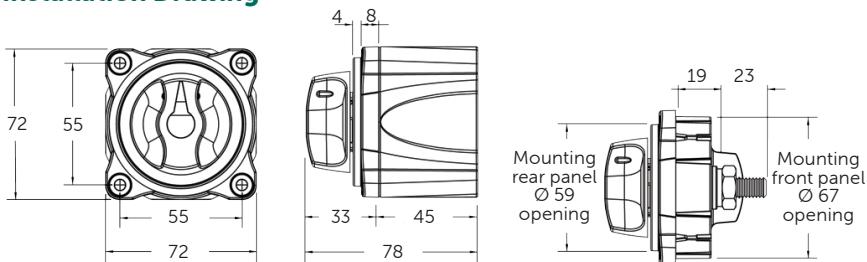

Mounting Options

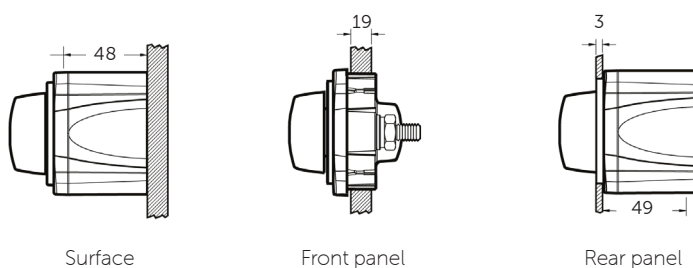

Circuit type ON-OFF

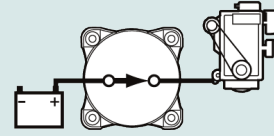

Switch set to 'ON'

Dual circuit

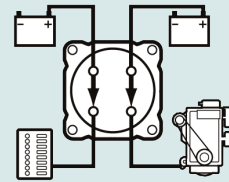

Switch set to 'ON'
Battery banks isolated

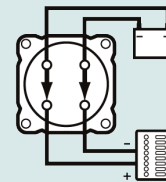

Switch set to 'ON'
One battery bank

Dual + Combine circuit

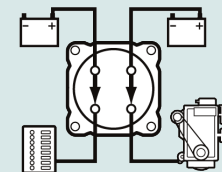

Switch set to 'ON'

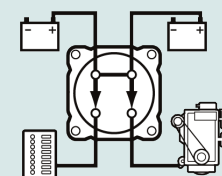

Switch set to 'Combine Batteries'



DC installations

Battery switches Heavy duty - Series

Quality products designed for harsh environments and built to last



Features and Benefits

- Robust and compact design
- Tin-plated copper studs for maximum conduction and corrosion resistance
- Multiple cable terminals, 22 mm thread
- One-piece terminal prevents parts loosening
- Multiple cable input enables surface front or built-in panel mounting
- Circuit identification labels included
- CE marked
- UL certified in accordance with UL 1701 (power switches)
- ABYC compliant
- Conforms to UL 1500 SAE J 1171 external ignition protection requirements
- IP66 protection rating



WP-HD Heavy Duty Series



DC SWITCH 600 A ON-OFF

50214711



DC SWITCH 500 A SELECTOR 4 POS

50214712

TECHNICAL SPECIFICATIONS

Product type	Hand operated battery switch	Hand operated battery switch
Switching	ON-OFF	Select from 4 positions
INPUT		
Number of batteries	1	2
Number of switching positions	2	4
Combine batteries	-	Yes
I 10 inrush current 10 sec.	2750 A	2750 A
I 60 inrush current 1 min.	1325 A	1150 A
I 300 C interrupted 5 min.	900 A	700 A
I C continuously	600 A	500 A
Maximum operating voltage	32 VDC	32 VDC
GENERAL		
Ambient operating temperature	-20 up to 40°C	-20 up to 40°C
Storage temperature	-25 up to 85°C	-25 up to 85°C
Relative humidity	95 %, non-condensing	95 %, non-condensing
MECHANICAL SPECIFICATIONS		
Thread connections	M12	M12
Length threaded stud	22 mm	22 mm
Maximum torque	24.86 Nm	24.86 Nm
Material threaded stud	Tin plated copper	Tin plated copper
Dimensions (W x D x H) in mm	98 x 79 x 98	98 x 79 x 98
Weight	590 g	590 g
Borehole spacings	76 mm	77 mm
Mounting diameter behind panel	92 mm	92 mm
Connection screws	M6	M6
International Protection rating	IP66	IP67
Housing colour	RAL9011 graphite black	RAL9011 graphite black
Cable opening	27.9 mm	27.9 mm
Ignition protection	UL 1500 SAE J1170	UL 1500 SAE J1171
Certification	CE, ISO 8845	CE, ISO 8846

Circuit type ON-OFF

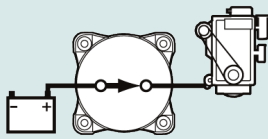

Switch set to 'ON'

Circuit type selector 4 positions

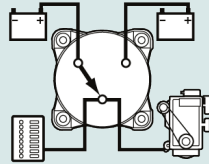

Switch set to '1'

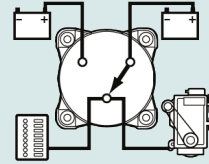

Switch set to '2'

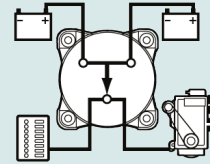

Switch set to '1+2'

Installation Drawing

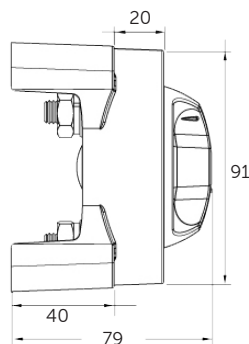
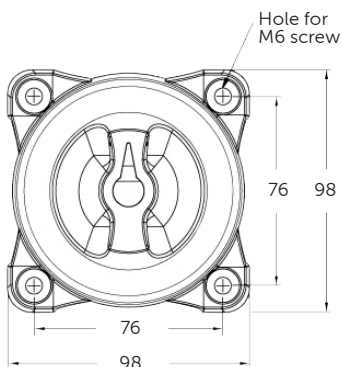

Mounting Options

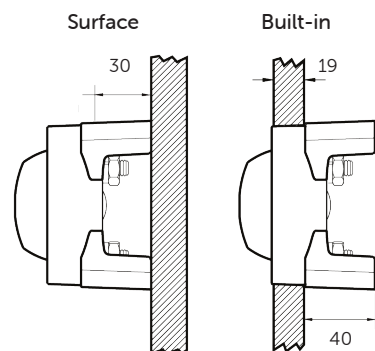

DC installations

Charging individual battery banks

Our electronic WBI Battery Isolators are designed to charge two or more individual batteries or battery banks from one power source: a battery charger or a DC alternator. The WBI is an ideal solution when the output voltage of a charge device cannot be adjusted to compensate for a voltage drop which occurs when an ordinary Battery Isolator is being used. The WBI keeps the charge voltage at the correct charge level.



The WhisperPower electronic Battery Isolator is the best on the market for simultaneously charging multiple battery banks. Plus it can be combined with any alternator or battery charger. It is designed for both existing and new installations without the need to adjust to the alternator. Because the voltage loss between the alternator and the battery is negligible, an electronic Battery Isolator performs much better than conventional models. As a result, the batteries are charged quickly and completely. The WhisperPower Battery Isolator uses electronics ensuring that the charging voltage remains at the correct level even with multiple battery banks, whereas conventional Battery Isolators use less efficient diode isolators. WhisperPower Battery Isolators can be used anywhere, even on standard alternators with external reinforcement and voltage measurers when it can then be connected to the start contact IG.

Benefits:

- 2 or 3 battery banks quickly and completely charged
- Significant extension of battery life
- Suitable for charge current up to 180 A
- Combine with each alternator and / or battery charger - no adjustments required
- Start Contact compatible with all types of alternators for external excitation and voltage measurement
- Hardly any voltage drop over the Battery Isolator
- No voltage drop if the batteries are fully charged
- Prevents current flow from one battery to the other
- Ensures that the (starter) battery remains fully charged



WBI Series

180 A | 2 OUTPUTS | IG 180 A | 3 OUTPUTS | IG

Article Number	60115012	60115013
TECHNICAL SPECIFICATIONS		
Number of outputs	2	3
Maximum current	180 A	180 A
Nominal system voltage	12 or 24 VDC	12 or 24 VDC
Input voltage range	8 - 30 VDC	8 - 30 VDC
Voltage drop	0.0 VDC at 10 A / 0.1 VDC at 20 A	0.0 VDC at 10 A / 0.1 VDC at 20 A
Isolation to ground	> 500 VAC at 60 Hz	> 500 VAC at 60 Hz
Operating temperature	-40 up to 85°C	-40 up to 85°C
Conforms to	EN 50081-1 (Emission) EN 50082-1 (immunity) EN 60950-1 (safety)	
Dimensions (W x D x H) in mm	146 x 85 x 97	158 x 85 x 146
Weight	810 g	810 g
Warranty	5 years	5 years

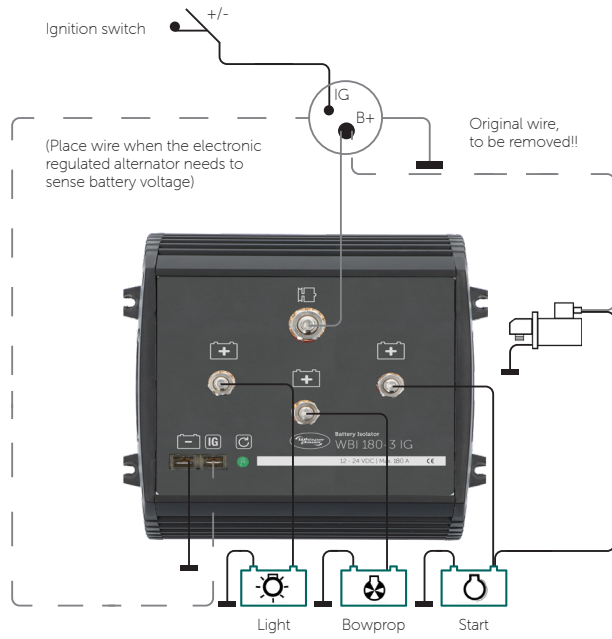

Dimensions WBI



Monitoring & Control

The Family

We live in a world where literally anything we want to know can be conjured up with a click of a mouse or a tick on a touch panel. With WhisperCare, we offer all relevant system information the professional or recreational user would like to have.



This is either through our 5,7 and 10 inch WhisperTouch panels, a local control already in place or via the cloud, connecting to computer, tablet or cell phone. Our new OctoControl communication centre connects the WhisperPower products with the WhisperTouch panel and/ or (both is possible) to a third party screen. Read more about these devices on the next pages.

Monitoring & Control

WhisperCare 1.5

[Go to Page 124](#)



1.5



Monitoring & Control

WhisperCare 2.0

[Go to Page 128](#)



2.0



Battery Monitor BMSS PRO

Go to Page 132



Smart Battery Monitor WBM Series

Go to Page 134



Battery Status Interface WPC-BSI-500

Go to Page 136



Isolated Communication Module WPC-RS232-i

Go to Page 138



WhisperCare 1.5

Remote monitoring, control and power management

In 2016, WhisperCare 1.5 was added as an important additional feature to WhisperPower systems as a key source to obtain remote system data.

Remote read-out and control is essential to efficiently operate and support one or more systems. A good example are the mobile units of the NHS (National Health Service, United Kingdom), used for mammographic scanning, powered by WhisperPower OctoPower systems equipped with WhisperCare 1.5. WhisperPower's fleet manager, vehicle supplier and service department are directly connected to the systems by WhisperCare. Over 50 trailers are now operational using WhisperPower systems with WhisperCare 1.5.

From the panel, the WhisperPower Generator, the Sine Wave Inverter / Charger combination and the batteries can all be monitored and operated. If there is already a central panel installed, for example for the navigation, we also offer the possibility of using the existing panel to monitor the WhisperPower system via an interface.

Battery Monitoring

- Battery voltage (V) and current consumption in Amps
- Activated charge current (charger, alternator, solar panels)
- "Time remaining" indication showing the time the battery can be utilized
- Ampere consumption (Ah)
- WhisperPower Generator start battery voltage indication

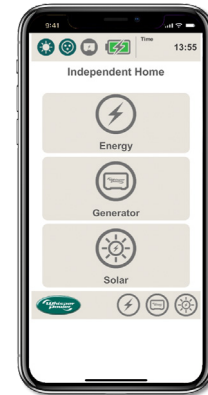

Main Menu

- Choose from ENERGY, GENERATOR and SETTINGS
- The WPC's and AC / DC PowerCubes most important settings can be programmed using the WhisperTouch panel

WhisperTouch: Three sizes available

The WhisperTouch panel is available in 5, 7 and 10 inches. This high resolution, full colour panel comes complete with cables and connectors for connection to the inverters / battery chargers and if also installed, the WhisperPower generator.



WhisperTouch Series

	5 INCH	7 INCH	10 INCH
Article Number	40280105 (generator-only use)	40280101	40280102
TECHNICAL SPECIFICATIONS			
Input voltage	6 - 42 VDC	6 - 42 VDC	15 - 36 VDC
Power consumption	100 - 240 mA	150 - 750 mA	100 - 650 mA
Dimensions *) (W x D x H) in mm	150 x 110 x 42	207 x 139 x 42	250 x 200 x 42
Weight	250 g	300 g	500 g
Operating temperature	- 25 up to 55°C	- 25 up to 55°C	- 25 up to 55°C
Installation advice	for interior use	for interior use	for interior use
Scope of supply	WhisperTouch panel, RS232 connection for WPC-RS232 -, RJ 45 converter / cable for WhisperPower generator, installation manual		
Compatible:	Yachtcontrol, Empirbus, NMEA 2000, Kabola, Webasto		

*) Outside dimensions, Installation depth

Dimensions and installation information

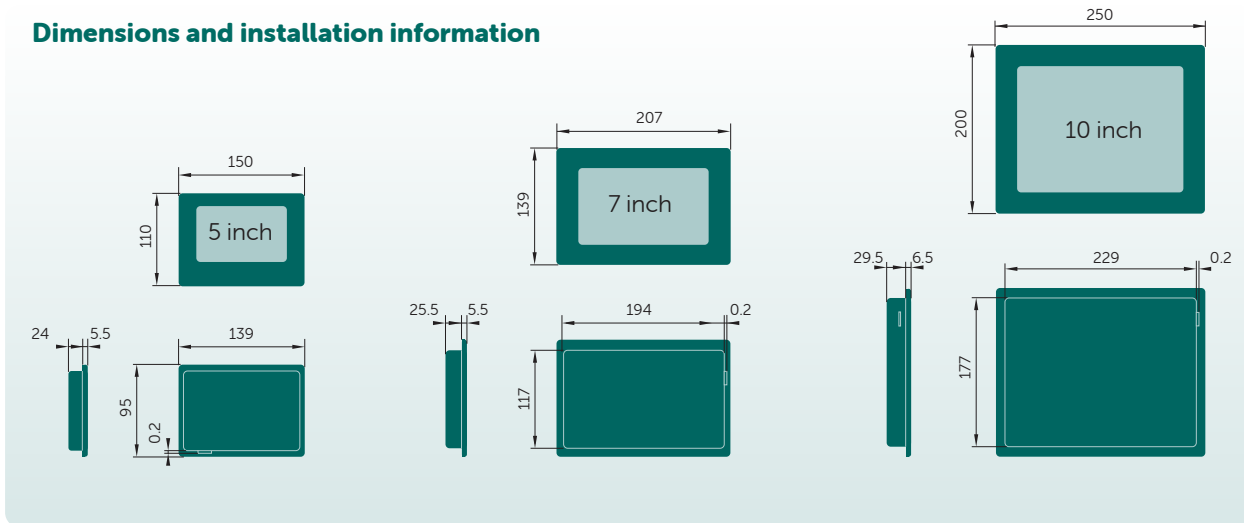

WhisperConnect Tool

The WhisperConnect Tool is one tool for monitoring, controlling and configuring your WhisperPower energy system. The WhisperConnect Tool uses the WhisperConnect CAN-bus to communicate to all WhisperPower equipment with WhisperConnect capabilities in a system. Simply connect the WhisperConnect CAN-bus to the computer using the supplied CAN to USB converter and you are ready to go. Due to the easy to use user interface you can have your system completely configured to your needs in no time at all.



WHISPERCONNECT TOOL

Article Number	40290370
DIMENSIONS & WEIGHT	
Weight	500 g
Dimensions (W x D x H)	230 x 320 x 70 mm
Storage temperature	-40 up to 80°C Relative humidity in operation/ storage up to 95% non condensing
SPECIFICATIONS	
Communication	WhisperConnect
Connection to computer	USB 2.0 type A
Connection to system	RJ45 or Micro C
RECOMMENDED SYSTEM REQUIREMENTS	
Operating system	Windows 7 or higher
CPU	Core 2 Duo or Athlon X2 at 2.4 GHz
Memory	2 GB of RAM
Hard drive	128 MB of free space

WhisperCare 1.5

Functional telematics

A key feature of WhisperCare 1.5 is the detection of the location of a vehicle or a vessel with the signalling of any malfunctions, visible on the computer screens or cell phone screen of a fleet manager, service technician or even the owner.

Including the ability obtain detailed information, from the WhisperPower generator, Lithium battery, Sine Wave Inverter and Battery Charger. This includes internal temperature measuring of the equipment, time - to - go service intervals, state of charge of the battery - with sms alarms.



System maintenance and memo

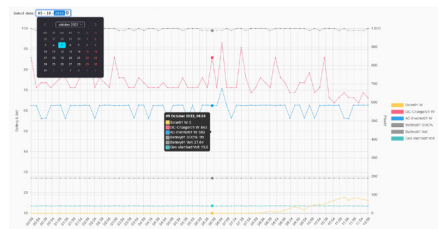
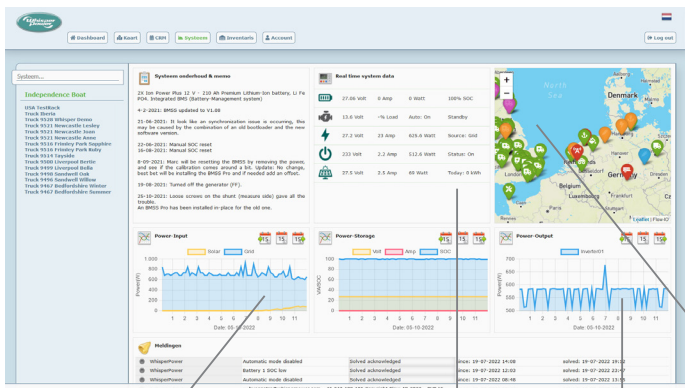

Historical Trend Data

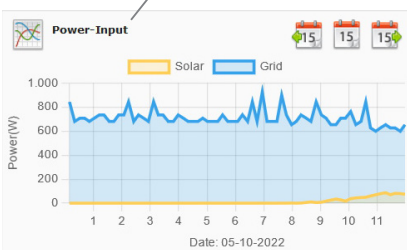

Power-Input

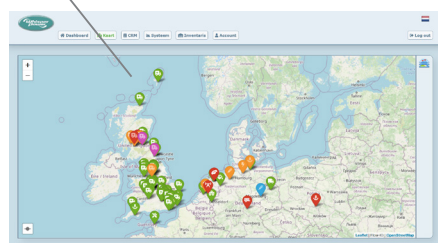

Map

Real time system data			
	27.06 Volt	0 Amp	0 Watt 100% SOC
	13.6 Volt	-% Load	Auto: On Standby
	27.2 Volt	23 Amp	625.6 Watt Source: Grid
	233 Volt	2.2 Amp	512.6 Watt Status: On

System Data

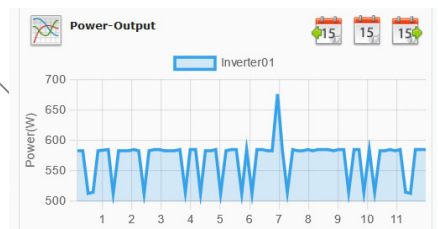

Power-Output



Accessories

WHISPERCARE 1.5 ROUTER

Article Number	Description
60116059	WP-DC WhisperCare LTE Cat 4 ROUTER 4G with GNSS – Dual SIM *)

*) Router will be delivered without SIM card. SIM card to be bought and paid by the end user from local telecom provider. Additional charge for hosting the local WP server will be charged separately for remote monitoring and data logging. Price on request.



ART. NR. 40290350

ART. NR. 40290360

ART. NR. 40290257

ART. NR. 40290258

ART. NR. 40290259

WhisperConnect terminator

WhisperConnect Splitter

Power Plus CAN-bus splitter

WP Power Plus CAN-bus terminator female

WP Power Plus CAN-bus terminator male

ART. NR.	WHISPERCONNECT PATCH CABLE
40290351	WhisperConnect Patch Cable 0.5 metre
40290352	WhisperConnect Patch Cable 1.5 metre
40290353	WhisperConnect Patch Cable 3 metre
40290354	WhisperConnect Patch Cable 6 metre
40290355	WhisperConnect Patch Cable 10 metre
40290356	WhisperConnect Patch Cable 15 metre
40290357	WhisperConnect Patch Cable 25 metre
40290358	WhisperConnect Patch Cable 100 metre
40290365	WhisperConnect DIY Patch Cable (do it yourself)



Control and monitoring of the WhisperPower generator

- Start/stop including ignition period
- Set automatic start - based on DC voltage
- Indication of starter battery condition
- Current (A), voltage (VAC), frequency (Hz) read outs
- Time to service indication
- Logged running hours

Remote control and monitoring: inverter / battery charger WPC & Battery

- Switch the entire inverter system ON-OFF
- Charger-only - the inverter is not activated if land power is switched off or cuts out
- Advanced battery monitoring
- Set land power amperage
- Inverter status indicator
- Battery charger status indicator
- AC power input voltage
- AC power output voltage

Brand connections:



WhisperCare 2.0

Next generation cloud-based

With its in-house developed WhisperCare 2.0, WhisperPower has taken the next step towards secure, robust, easily accessible and cost-effective remote monitoring. Security and compliance are important to WhisperPower, the highest standards have been incorporated in the design.

Implementation of the new software in WhisperPower's systems is ongoing, linking to other systems such as navigation systems are easily achieved. The range of OctoControl interfacing devices makes connectivity at various system levels (local, cloud-based) easy.



Portal

Developed and maintained for end-users, fleet managers, dealers and service engineers alike.

Using WhisperCare leads to:

- Increased system efficiency
- Saves costs on cost of operation
- Pro-active support

Benefits of using the WhisperCare cloud portal

- Full control of your system from everywhere
- Uptime improvement using connectivity
- Performance improvement owed to data analysis
- Cost reduction through pro-active maintenance and support

Watch the status of all your systems in a single overview, on a map or in a summarized list. View a summary of advanced alerts, alarms and notifications from all your WhisperPower systems.

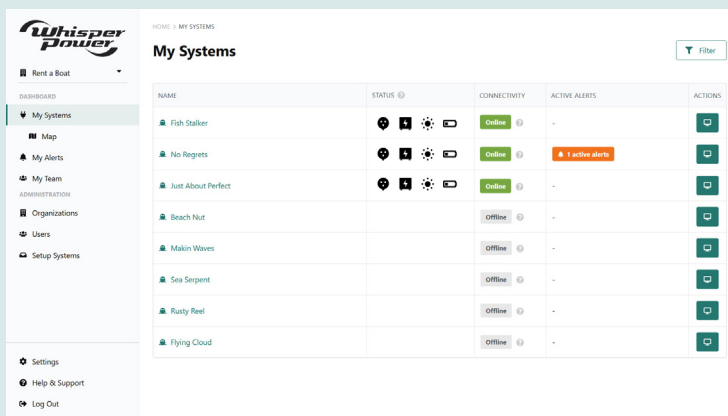

Real time monitoring

Detailed real time information, both on system level and on single device level.

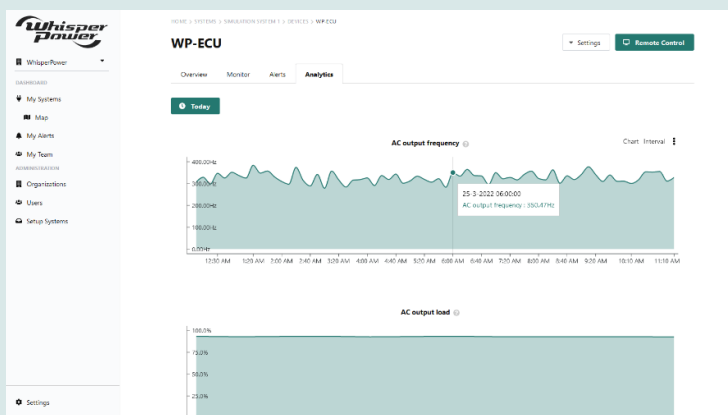

Historical trend data

Historical analytic gives insight in the usage and status of your WhisperPower system over a longer time. Full data can be viewed in graphs up to 3 years ago. Useful for diagnostics and pro-active maintenance.

WhisperCare 2.0

OctoControl User Interface

All information from your WhisperPower energy system (or OctoPower system) centralized and presented in an easy to read format. The OctoControl modules collect real-time information from your WhisperPower system, process it and display it on your WhisperPower Touch monitor, a third party MFD or in the WhisperCare cloud interface.

Smart features:

- Generator automatic run request
- Day and night profile
- Advanced alerts, alarms and notifications

Thanks to the smart WhisperCare software, seamless integration to third parties like Garmin, Raymarine and Simrad is possible to control the complete WhisperPower system from your navigation screen, and other Multi functional displays.

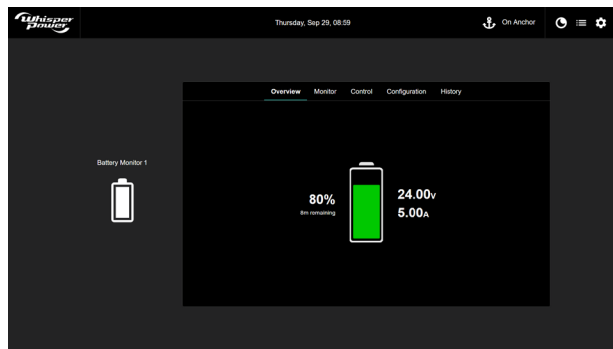
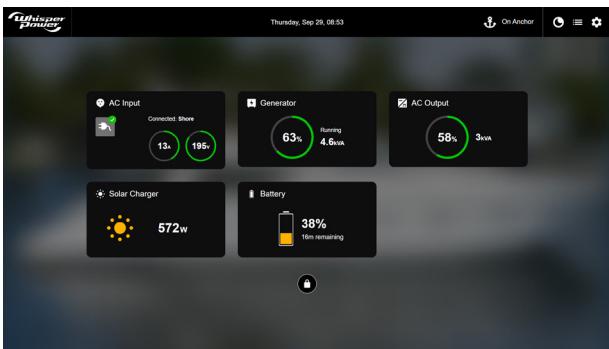

All system information presented in an easy to read format Full details and control of all WhisperPower equipment

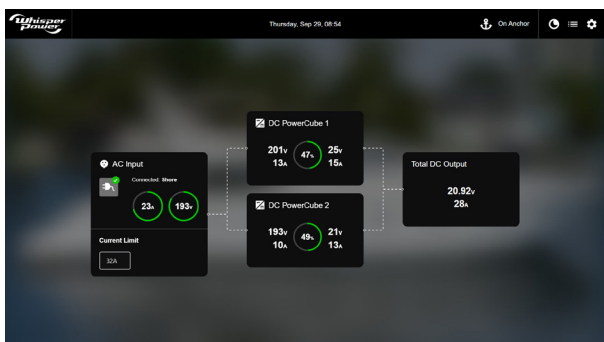

Summarized input and output power data combined from all chargers in a system

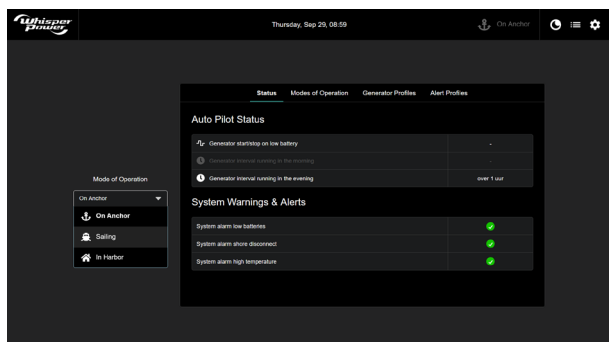

Smart features allows the use of automatic generator requests, different user profiles

WhisperCare 2.0

OctoControl Interfaces

OctoControl Gateway

Brings your WhisperPower system online in the cloud. Easy to install and use. It comes with built-in 4G connection and integrated E-sim, including three year data subscription as a standard.

Monitor systems up to three devices

Direct integration to the cloud

Connections

Power supply

GSM antenna

Built-in 4G connection, no external router equipment needed

Readout from online WhisperCare cloud portal

Readout on phone/tablet from anywhere

WhisperConnect connection to your WhisperPower system

OctoControl Basic

Ideal for integrating your WhisperPower system into a third party MFD, like Garmin, Raymarine, Simrad, B&G.

Connections

Power supply

Ethernet connection for MFD integration

Readout on third party MFD touch panels

Smart system control modules, like auto start

No WhisperCare cloud integration

WhisperConnect connection to your WhisperPower system

OctoControl Series

	GATEWAY	BASIC	PRO
Article Number	60208010	60208015	60208025
SPECIFICATIONS			
Input voltage	8-32 VDC	8-32 VDC	8-32 VDC
Power consumption	< 100 mA at 12 VDC *	< 500 mA at 12 VDC *	< 500 mA at 12 VDC
Operation temperature	-20°C to +40°C	-20°C to +40°C	-20°C to +40°C
Storage temperature	-40 up to 80 °C, Relative humidity in operation/ storage up to 95% non-condensing		
TECHNICAL SPECIFICATIONS			
System communication	WhisperConnect only	WhisperConnect only	WhisperConnect***
System support	Up to 3 WhisperConnect devices	Complete WhisperConnect systems	Complete WhisperPower systems
Cloud integration	Yes	No	Yes
Cloud connection	Built-in 4G	N.A.	Built-in 4G **, Ethernet
OctoView support	No	No	Yes
OctoView connection	N.A.	N.A.	HDMI, USB
MFD brands supported	N.A.	Raymarine, Garmin, Simrad, B&G, Furuno**	Raymarine, Garmin, Simrad, B&G, Furuno**
MFD connection	N.A.	Ethernet	Ethernet
TECHNICAL SPECIFICATIONS			
Dimensions (W x D x H) in mm	107 x 40 x 140 *	167 x 40 x 140 *	267 x 40 x 145
Weight (kg)	< 0.5 *	< 0.5 *	< 0.5
Installation advice	For interior use	For interior use	For interior use

*Preliminary specifications, may change without notice **Prepared *** WhisperConnect, WPC-Bus, CanOpen, NMEA 2000



OctoControl Pro

Best of both worlds. Combine monitoring from a local WhisperPower Touch monitor, integrating in third party MFDs and connection to the WhisperCare cloud in a single module. Optionally with built-in 4G connection, so no external router equipment are needed.

Excellent to use with complex OctoPower systems

Smart system control modules, like auto start

Readout on third party MFD touch panels

WhisperCare cloud integration

Readout from online WhisperCare cloud portal



Connections

WhisperConnect connection to your WhisperPower system

Power supply

CAN-bus, configurable for third party devices

Dual RS485 communication, configurable to use for DDC bus

Ethernet connection for MFD integration

GSM/GPS antenna

Ethernet for cloud integration

HDMI output for use with WhisperPower Touch monitor



OctoControl Pro System



For fleet managers, end users with complete systems and MFDs

- Complete, OctoPower systems
- Smart system control modules, like auto start
- Readout on third party MFD touch panels
- WhisperCare cloud integration
- Readout from online WhisperCare cloud portal

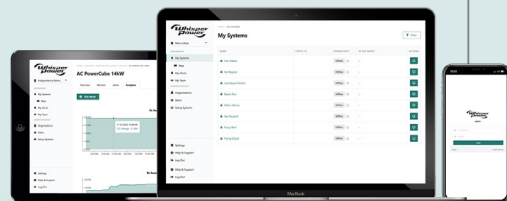
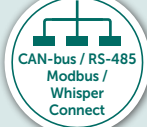

Battery Monitor

BMSS PRO

The BMSS Battery Monitor Smart Shunt completes your WhisperPower energy supply system by providing full details about the state of your battery or battery bank. All information is communicated via WhisperConnect, thereby integrating this product into a range of battery chargers, generator sets and inverters from WhisperPower, to be read out by the WhisperTouch control panels.

The BMSS Pro is a professional measurement device which has to be installed close to the battery. In combination with one of the WhisperTouch panels, this is the most advanced battery monitor you can find. The BMSS controls the key parameters of the batteries: automatic charge devices can be programmed such as a battery charger, Combi and a diesel generator. The BMSS Pro matches perfectly with all other interface devices and makes the system rock solid.

The diagram illustrates the installation of the WP-BMSS Pro. The monitor is connected to a battery (indicated by a + - symbol). It also connects to a WhisperConnect terminator (a green RJ45 plug), a WhisperTouch panel (a tablet displaying battery status), and a temperature sensor (WP-ITS) with a 1.5m cable. A 5-year warranty badge is also shown.

WHISPERCONNECT TERMINATOR (NOT INCLUDED)	WHISPERTOUCH PANEL (NOT INCLUDED)	TEMPERATURE SENSOR + CABLE 1.5 m (INCLUDED)
Art. Nr. 40290350	Art. Nr. 40280105 5 inch Art. Nr. 40280101 7 inch Art. Nr. 40280102 10 inch Art. Nr. 40280103 7 inch NMEA 2000	Art. Nr. 60201201

Accessories included

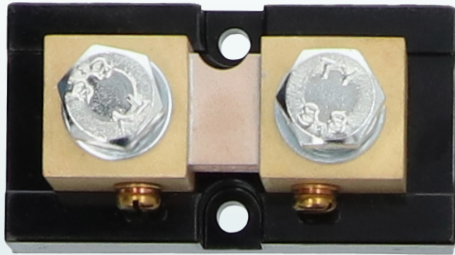

ART. NR. 40290320

Shunt 1200 A / 50 mVDC

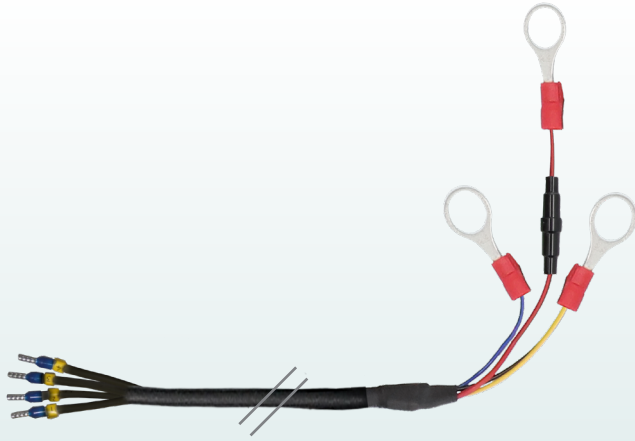

ART. NR. 40290326

Shunt Connection Cable

BMSS PRO

Article Number 40290323

SPECIFICATIONS

Power supply voltage	6-60 VDC
Current draw (standby)	<9 mA at 12 VDC
Operating temperature	-20 up to +60°C
Voltage measurement range	6 - 60 VDC
Battery capacity	20 - 9999 Ah
Shunt compatibility	50 - 1000 A, 50 - 60 mVDC
Voltage resolution	± 0.001 VDC
Current resolution	± 0.1 A
Amp hour resolution	± 0.1 Ah
Time remaining resolution	0 - 480 hours, ± 1 minute
Temperature resolution	± 1°C
Voltage measurement accuracy	0.3 %
Current measurement accuracy	0.4 %
Temperature accuracy	± 2°C
State of charge accuracy	± 1 % of battery capacity

Local user interface	Status LED, ROM
External communication	WhisperConnect (CAN-bus) WP temperature sensor - USB
Multipurpose contact	2 nc/no potential free contacts
Operation temperature	-20 up to 40°C

ALARM CONTACTS

Voltage	24 VDC
Current	1 A
Measurement shunt included	1200 A, 50 mV

WEIGHT AND DIMENSIONS

Weight	< 500 g
Dimensions (W x D x H) in mm	90 x 50 x 75
Storage temperature	-40 up to + 80°C Relative humidity in operation/ storage up to 95% non-condensing

Drawing BMSS Pro

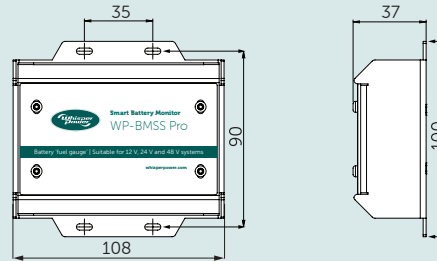

Drawing Smart Shunt Pro

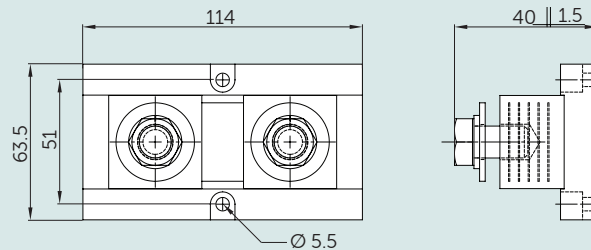

Connection Diagram

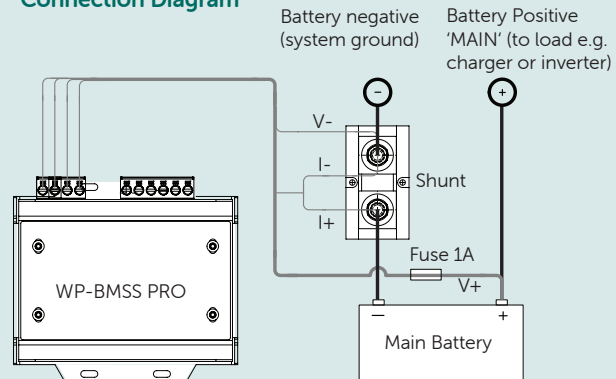

Smart Battery monitoring - the traditional way

A look inside the battery

When putting together a DC installation, there is more to take in to consideration than just the correct choice of battery and associated charging systems. All sorts of other items can have something to do with the battery or are connected to it and can significantly impact the end result.



WBM-MODULAR SMART SHUNT *)

Article Number	40290313	
TECHNICAL SPECIFICATIONS		
Supply voltage range	7 - 70 VDC	
Supply current **) at 24 VDC	6 mA	
	at 12 VDC	10 mA
Input Voltage range (auxiliary battery)	7 - 70 VDC	
Input Voltage range (main battery)	1 - 70 VDC	
Input current range ampere ***)	-600 up to 600 A	
Battery capacity (min. - max.)	10 - 10.000 Ah	
Operating temperature	-20 up to 50°C	
Readout accuracy: voltage	± 0.01 VDC	
current	± 0.1 A	
battery capacity	± 0.1 Ah (0 - 10.000 Ah)	
battery capacity	± 1 Ah (200 - 10.000 Ah)	
start of charge (0 - 10 %)	± 1 %	
time remaining (0 - 24 h)	± 1 minute	
time remaining (24 - 240 h)	± 1 hour	
temperature (-20 up to 50°C) ****)	± 0.5°C	
Voltage measurement accuracy	± 0.3 %	
Current measurement accuracy	± 1 A (0.600 A)	
Housing material	ABS	
Colour	RAL 7021 black grey	
Dimensions: diameter front panel / cylinder	ø 64 mm / ø 51.5 mm	
Weight	Display: 70 g Shunt: 260 g	
Shunt Dimensions (W x D x H) in mm	100 x 100 x 64	
International Protection rating	IP20 (front panel IP65)	

Dimensions WBM Modular Smart Shunt

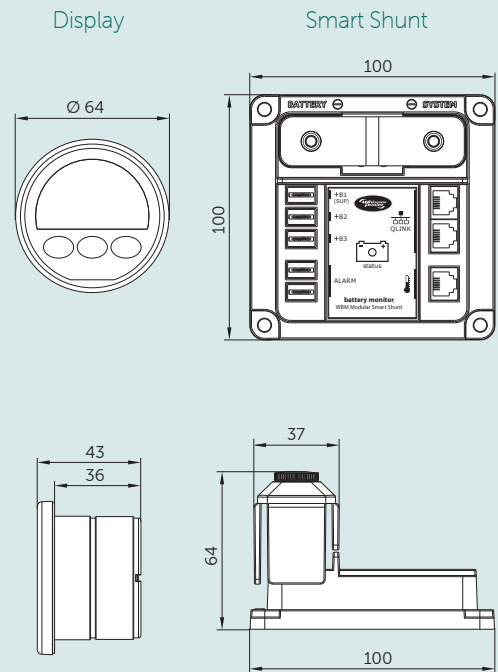

*) Shunt to meter cable included

**) Measured with backlighting and alarm relay switched off

***) Subject to selected shunt. With 500 A / 50 mV shunt (350 A continuous delivered as standard the range is -600 up to 600 A

****) Only available if optional temperature sensor (Art. Nr. 40290304) is connected

WBM Series



WBM-BASIC

WBM-PRO

Article Number	40290310	40290311
TECHNICAL SPECIFICATIONS		
Supply voltage range	9 - 35 VDC	9 - 35 VDC
Supply current *) at 24 VDC	7 mA	7 mA
at 12 VDC	9 mA	9 mA
Input Voltage range (auxiliary battery)	2 - 35 VDC	2 - 35 VDC
Input Voltage range (main battery)	0 - 35 VDC	0 - 35 VDC
Input current range ampere **)	-999 up to 999 A	-999 up to 999 A
Battery capacity (min. - max.)	20 - 999 Ah	20 - 999 Ah
Operating temperature	-20 up to 50°C	-20 up to 50°C
Readout accuracy: voltage	± 0.1 VDC (0 - 35 VDC)	± 0.1 VDC (0 - 35 VDC)
current	± 0.1 A (0 - 100 A)	± 0.1 A (0 - 200 A)
current	± 1 A (100 - 999 A)	± 1 A (200 - 999 A)
battery capacity	± 0.1 Ah (0 - 100 Ah)	± 0.1 Ah (0 - 200 Ah)
battery capacity	± 1 Ah (100 - 999 Ah)	± 1 Ah (200 - 999 Ah)
start of charge (0 - 10 %)	± 0.1 %	± 0.1 %
time remaining (0 - 24 h)	N/A	± 1 minute
time remaining (24 - 240 h)	N/A	± 1 hour
temperature (-20 up to 50°C) ***)	N/A	± 0.5°C
Voltage measurement accuracy	± 0.3 %	± 0.3 %
Current measurement accuracy	± 0.4 %	± 0.4 %
Housing material	ABS	ABS
Colour	RAL 7021 black grey	RAL 7021 black grey
Dimensions: diameter front panel / cylinder	ø 64 mm / ø 52 mm	ø 64 mm / ø 52 mm
Total depth / weight	79 mm / 95 g	79 mm / 95 g
Shunt Dimensions (W x D x H) in mm	87 x 45 x 34	87 x 45 x 34
Weight (Shunt + Meter)	145 g	145 g
International Protection rating	IP20 (front panel IP65)	IP20 (front panel IP65)

Dimensions WBM Basic/Pro

Display

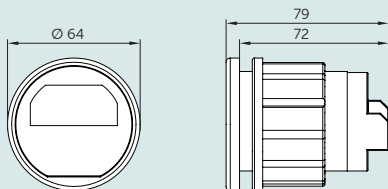

Shunt

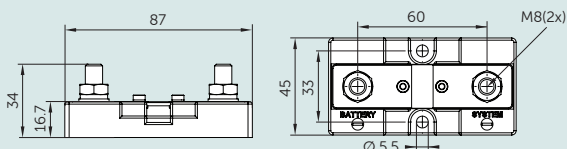

*) Measured with backlighting and alarm relay switched off

**) Subject to selected shunt. With 500 A / 50 mV shunt (350 A continuous) delivered as standard the range is -600 up to 600 A

***) Only available if optional temperature sensor (Art. Nr. 40290304) is connected

Battery usage indicator - knowledge is power

The WBM is a universal battery monitor that displays the status of the battery with very high precision. Via the display, the following information is brought up:

- The main battery voltage (VDC)
- The power consumption indicated in ampere-hours (Ah)
- Power consumption in Amps (A)
- Charge current of battery charger, Combi, solar panels, windmills, etc. (A)
- Battery capacity in %
- Remaining battery capacity and "time remaining" in minutes and hours (Pro Series) The WBM provides a look 'inside' the battery and is essential for preserving long battery life

Remote communication

The WBM, fitted with the WPC-RS232-i option, can be used to remotely monitor power systems using a GSM or an internet connection.

Three versions

The WBM Basic version is identical to the PRO version, only without the "time remaining" indicator in hours and minutes. The PRO-HV is suitable for DC systems up to 70 VDC.

Automatic start function

The WBM can also be used as a means of automatically starting a DC or AC generator, based on the battery voltage or battery condition. This is achieved via WPC-RS232-i communication (order WPC-RS232-i option) Please note that your generator must be suitable for this function. WhisperPower generators are equipped with an automatic start / stop adjustment kit as standard.



Art. Nr. 40290304

WBM Temperature Sensor Kit - 10 metre

WPC-BSI-500

Battery Status Interface

One of the most important indicators for a safe and effective operating of an energy system with batteries is their state of charge. The BSI offers, for WhisperPower Center, a highly precise measuring and an extremely efficient algorithm that calculates the state of charge in the most accurate way.

**The complete package**

Battery Status Interface

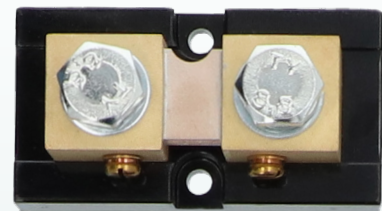

Shunt 500 | 50 *)



Connection cable 5 metre

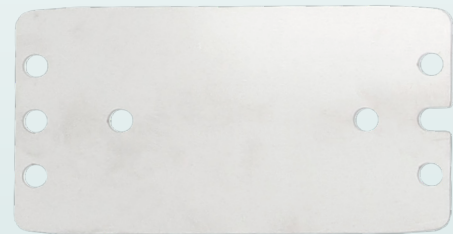

Fixing plate

*) Shunt 1200 | 50 optional

By adding the WPC data logger (see page 138), provides the data logging, the graphical display of the state of charge history and the settings. Values of the BSI can be used in the programming of the WPC Series. Values can be displayed like for instance:

- State of charge
- Voltage
- Current
- Time to go
- Throughput energy
- Battery temperature

SHUNT

Article Number	Item
60201087 Standard included	Shunt 500 A / 50 mVDC
60201088 Optional	Shunt 1200 A / 50 mVDC

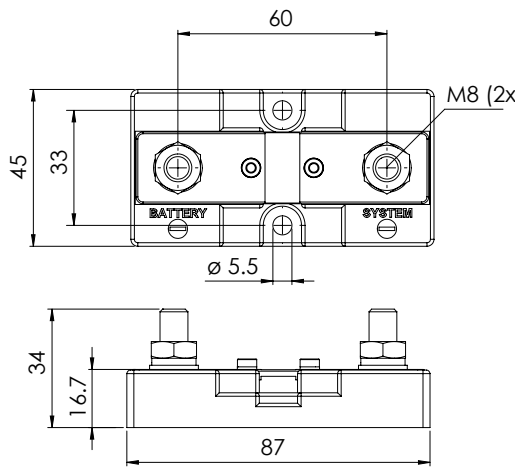
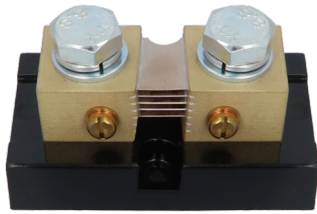

WP-BSI-500

Article Number	60201082
----------------	----------

SPECIFICATIONS

Supply voltage range	7.85 VDC
Supply current	9 mA at 12 VDC 5 mA at 24 VDC 3 mA at 48 VDC
Input voltage range	7.85 VDC
Shunt measurement input range	± 195 mV
RMS continuous current at 25 °C	± 500 A
Maximum measurable peak current	± 1950 A
Voltage measurement accuracy	0.3 %
Current measurement accuracy	0.5 %
Battery capacity	20 - 20000 Ah

READOUT RESOLUTION

Voltage	± 0.01 VDC
Current (A) and capacity (Ah)	± 0.01 VDC (1 to 10) ± 0.1 VDC (10 to 100) ± 1 VDC (100 to 9999)
State of charge	± 0.1 %
Temperature	± 0.1 °C
Time to go	± 1 second

READOUT INFORMATION

Battery voltage
Current, state of charge
Power used
Time to go
Battery temperature
Relative capacity
Historical Ah data
Total Kah charged
Total Kah discharged
Total time: Charge counting in Ah and hr.

GENERAL

Operation temperature	-20 up to 40 °C
Dimensions (W x D x H) in mm	75 x 26 x 110.5
Weight	900 g
Protection degree	IP20

Conformity LVD 2006/95/EC, EMC 2004/108/EC, RoHS 2002/95/ECEN 60950:2005, EN 61000-6-2:2005, EN 61000-6-3:2007

Example of use

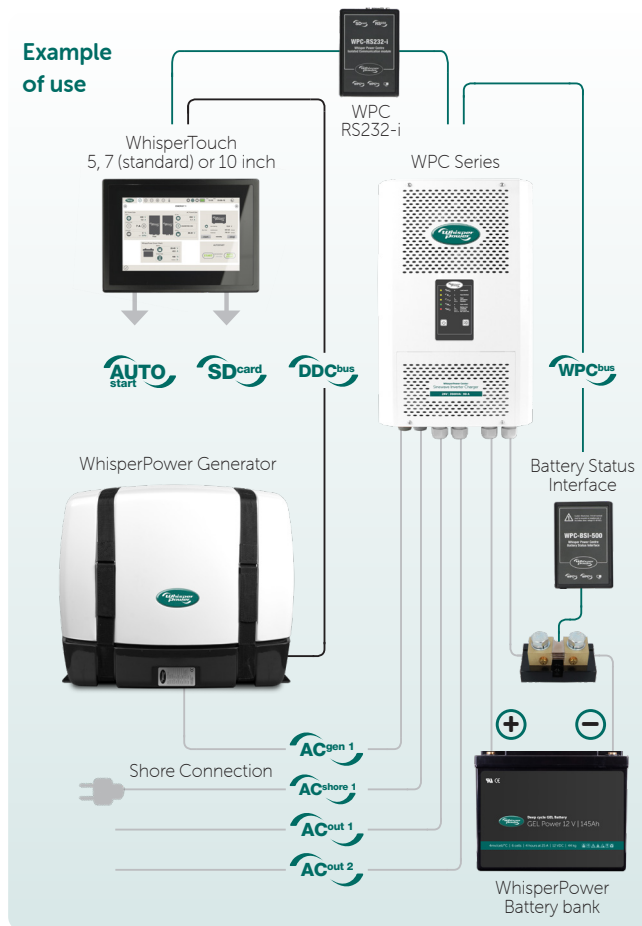

WPC-BSI-500

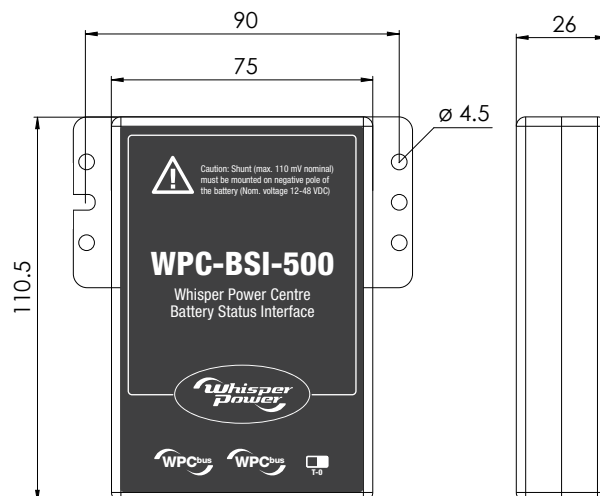

WPC-RS232-i

WhisperPower Center Communication Interface

The WPC is an allround sine wave inverter/charger, designed to operate as the heart of a complete energy system, equipped with or without generator.



The WPC can operate as an offgrid inverter-only, or inverter/ battery charger combined, features a build - in "traffic" system between various AC sources and produces additional output power when connected in parallel to AC mains/ land power and / or generator power. The WPC product is premium system component, based on low-frequency, toroidal transformer technology with heavy duty, high efficient mosfets taking care of an accurate alternating current (AC) current. WhisperPower can configure the WPC's by stacking the units in parallel up to 72 kVA output power, in single or three phase.

System link

The WPC is fitted with an RS232 analogue communication port which can be used to link the WPC to a complete WhisperPower system and the WhisperTouch panel (and WhisperCare) in particular. In this chapter all relevant components are described which are required to set - up the WPC for a proper system integration. The main accessory is the WPC - RS232 interface, which enables to read out all essential information from the WPC and change, if needed, change parameters to adapt the configuration. This device is enabling data transmission to GSM modems, computers and RS232 bridges to TCP/IP. The integrated SD card stores all important data related to the entire power systems including the process of battery charging, battery usage, load connected and the behavior, charge cycles etc.

The complete package

Article Number: 60201084



WPC-RS232-i



Connection cable 2 metre



Fixing plate

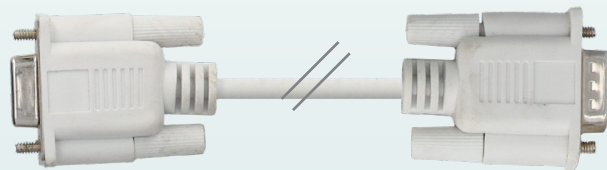

RS232 cable



DIN Rail Holder



Micro SD card



Mounting Bolts

WPC-RS232 communication

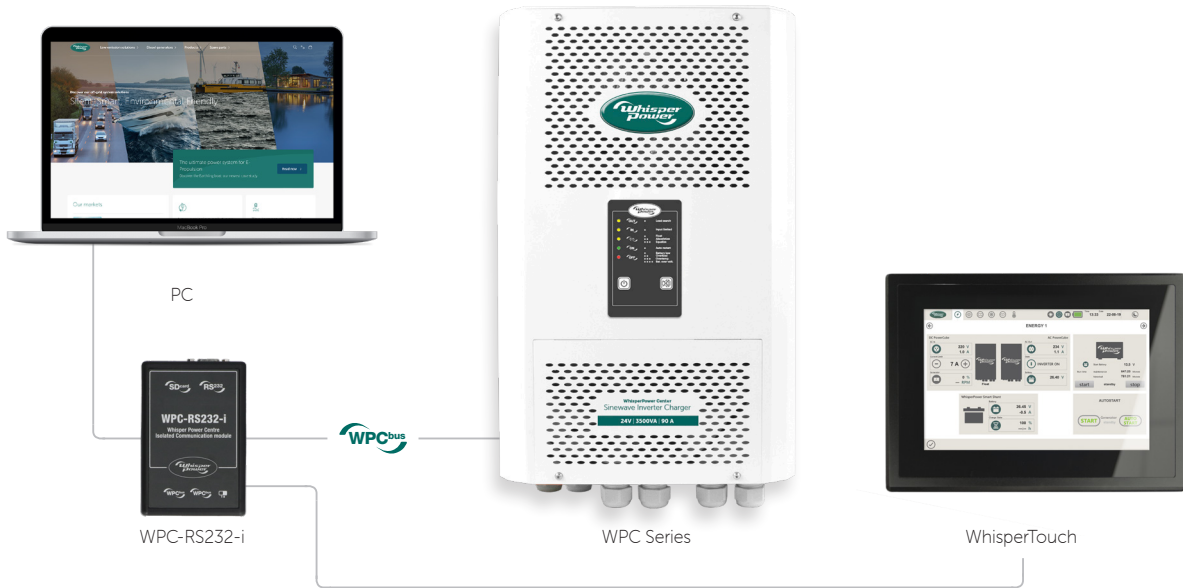

Connections

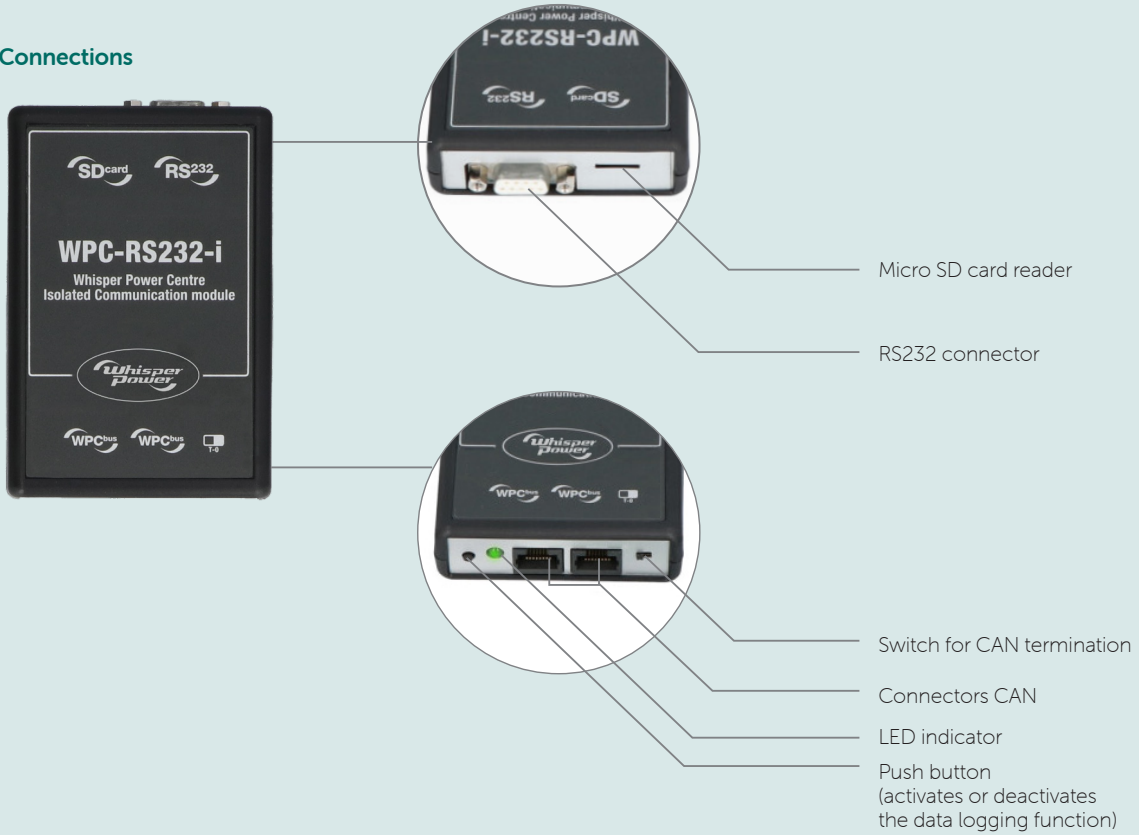

Dimensions

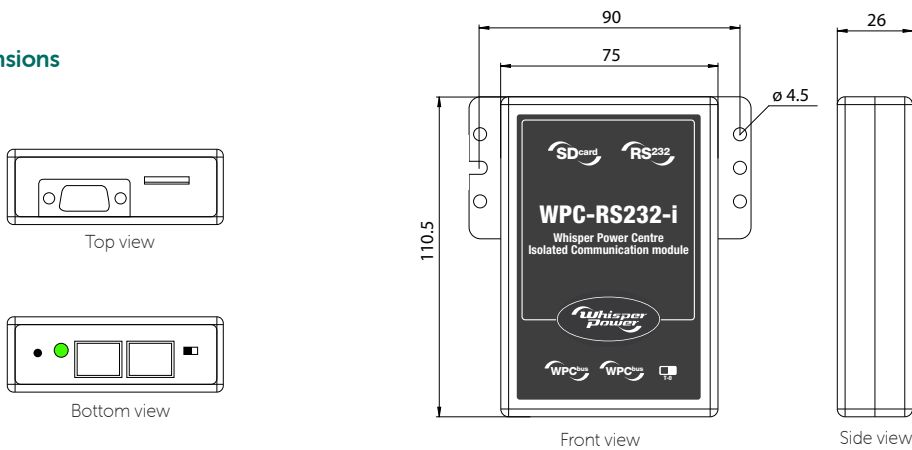

System

Example 1

Electric refrigerated truck

- Supreme Combi 3000 W | 100 A (230 VAC)
- 100 A 12 VDC Charging capacity
- Lithium battery 5 kWh | 12 VDC
- Solar roof with MPPT charge

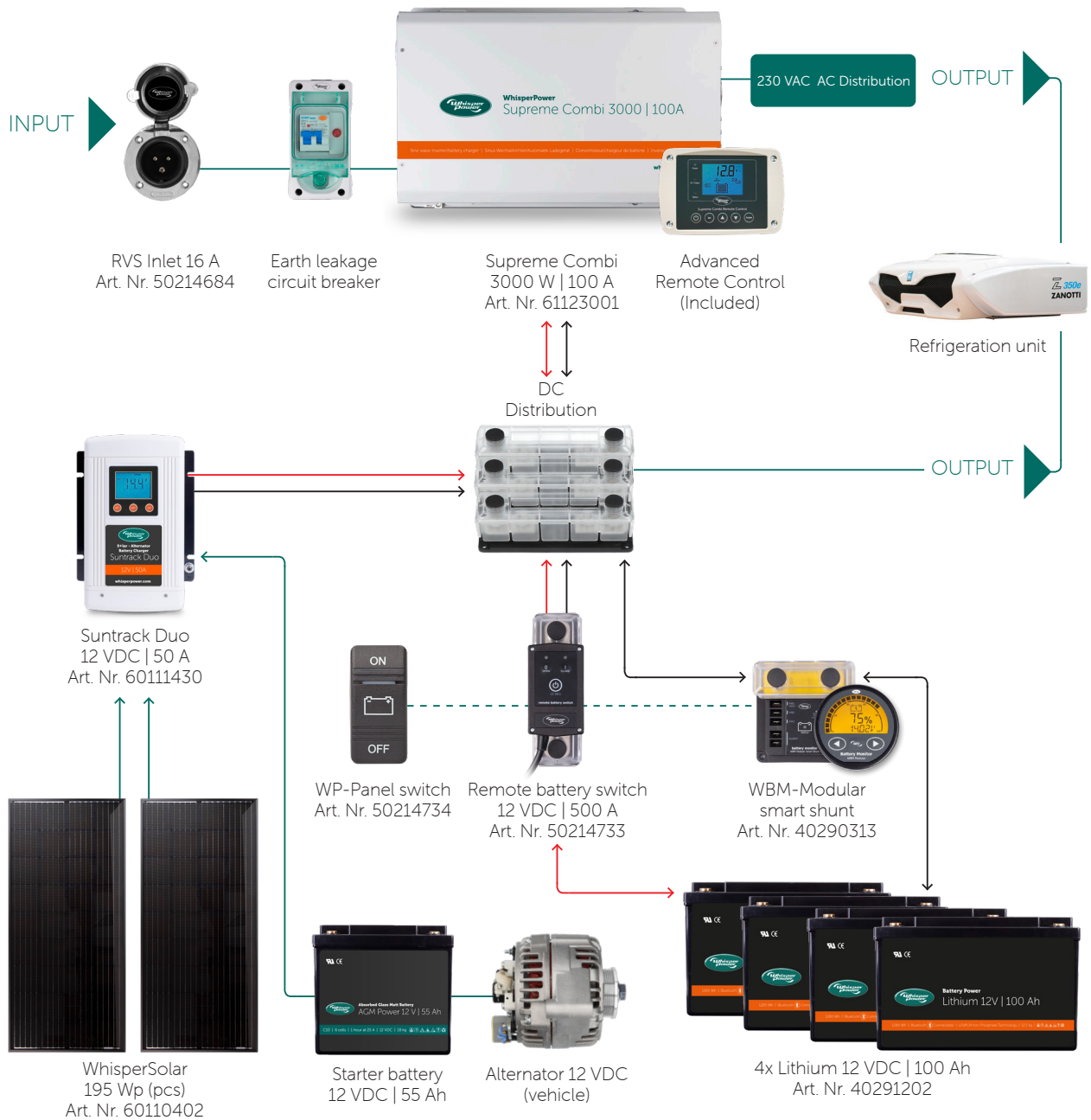

System

Example 2

Motorhome

- Inverter: WP Sine 12 VDC | 3000 A
- Charging power Battery Charger Supreme 12 VDC | 60 A
- Solar MPPT & Booster: Suntrack Duo 12 VDC | 50 A
- LiFePo4 battery bank 12 VDC | 300 Ah

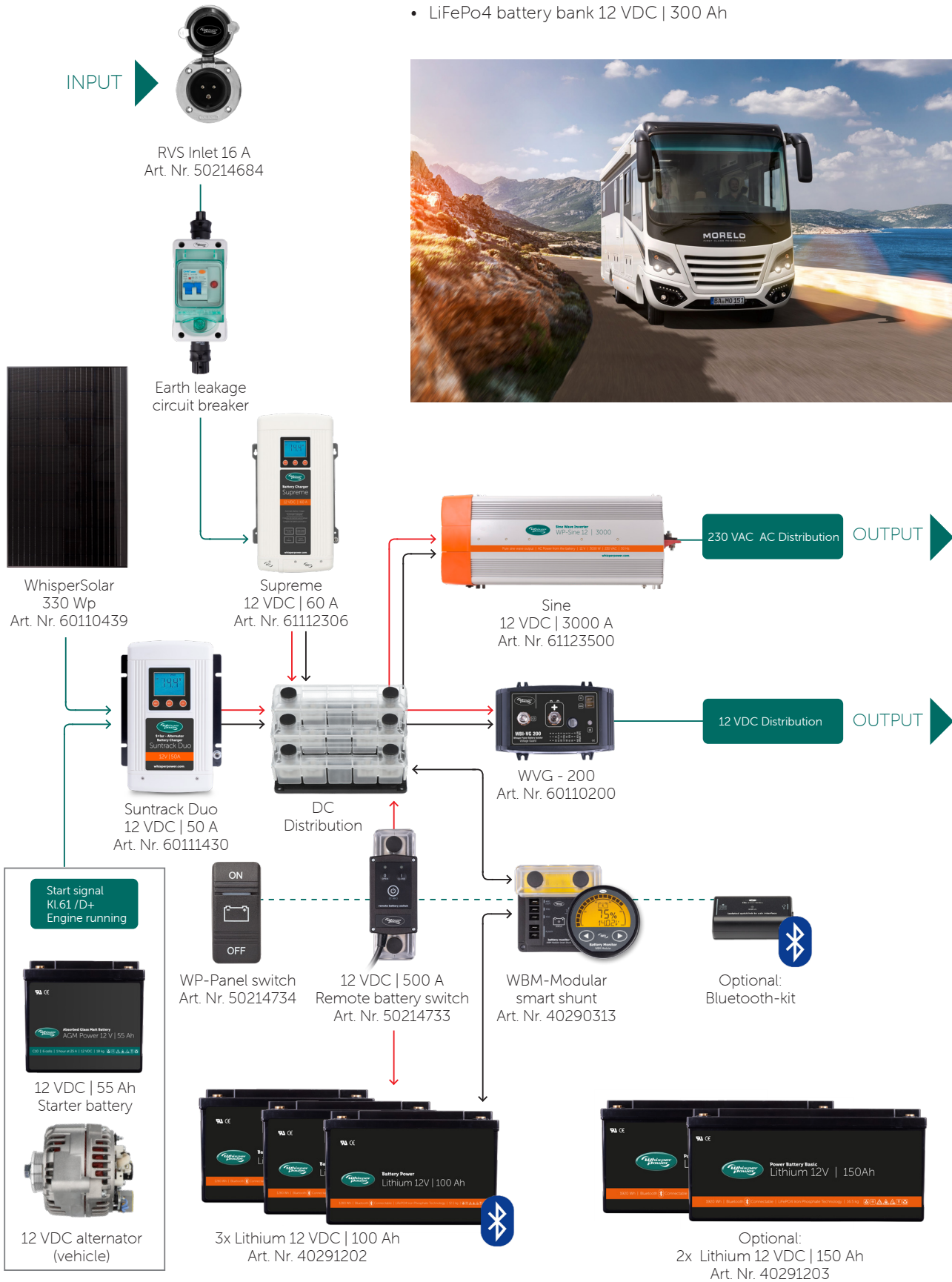

The Company

WhisperPower was founded in 2007 for the manufacturing of diesel generators and related items. Up to 2010 these products were sold under the Mastervolt brandname. Since then, the company has quickly and successfully grown and developed especially in terms of innovation and quality.

In 2009 Hybrid Power Systems BV was founded to develop and produce combined hybrid power and propulsion systems for superyachts and commercial vessels. Since 2010, the product portfolio has been significantly expanded with products and components which form complete electrical systems for vehicles, vessels or locations which do not have (permanent) connection to the public grid. They can be assembled for Plug and Play solutions.

WhisperPower has used its years of experience in developing systems containing a diesel engine to develop in-house, a new generation of power electronics. The product range covers power range options from 500 W to 500 kW.



In-house production

A large proportion of WhisperPower's production takes place in a modern 5500 m² factory in the Netherlands where work is done in accordance with ISO standards. Each integrated diesel product is tested extensively (3 hours) and receives a test certificate.

International Network

A comprehensive network of national and international dealers, installers and distributors ensures that WhisperPower products and systems find their way to the end user. In many countries, the network operates from an established WhisperPower commercial site. Service and warranty come first for us! For an overview of our network, please go to: www.whisperpower.com/where-to-buy



Manufacturing

Most of the manufacturing process is carried out in-house in our 5500 m² building, located in Drachten, Friesland, the Netherlands. The building is a showcase for the very latest thinking in terms of energy-friendly sustainability and includes facilities such as solar cells and climate control based on an eco-energy recovery system. We save as much energy as possible in all our daily operations, using thermal storage for residual heat or power. All our products and systems are severely in-house tested before shipping.

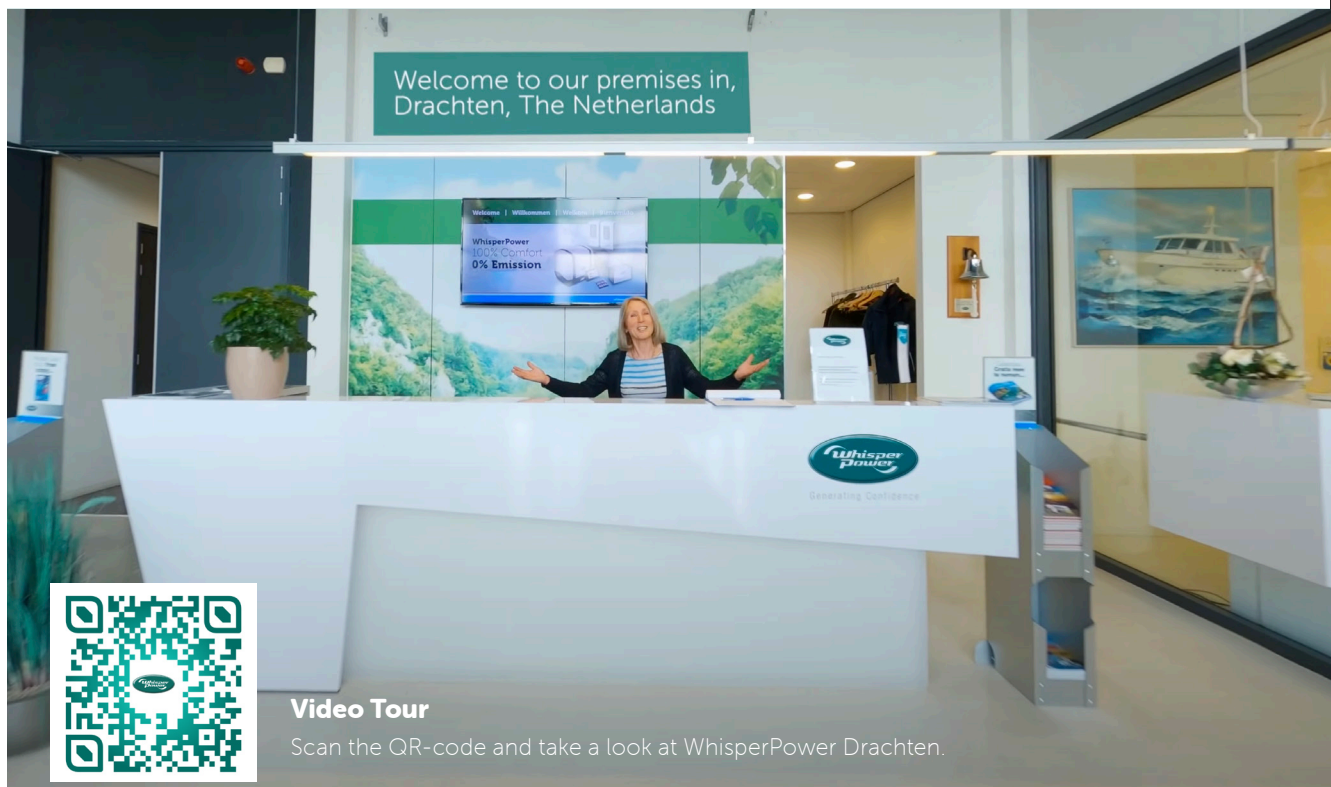

Delivered anywhere, anytime

WhisperPower Service & Support

At WhisperPower, service and support goes beyond production and sales. We are and happily remain responsible for our products, systems and accessories. You can therefore count on all the necessary service and support both before and after your purchase. From initial system advice through to installation and from commissioning to outstanding maintenance and warranty support, first class service is our aim and priority.

System advice and design focused on your specific needs

Our engineers and advisers have extensive experience in the development and implementation of electrical systems.

They take pride in helping you make the right plans for your system's exact needs, be it the installation of a Genverter® or generator or more comprehensive and complex systems. We design a fit for purpose system with optimum efficiency. This hard and fast rule also applies if you are combining a generator system with, for example, an inverter, battery charger or solar or wind power.

Global Sales and Distribution network

The ever growing WhisperPower network of dealers and distributors can be found all over the world.

Our international brand is locally represented by sales and distribution partners and importers. Specialists in their field, well-trained across the product range and professional, they are on hand and happy to assist for mobile, maritime and domestic applications.

Commissioning and System set up

Once delivered, WhisperPower's technical team also takes care of the installation and commissioning of the generator system where possible. In some countries - including the Benelux region - this service is included. You can, therefore, rest assured that your system is installed according to the appropriate guidelines and terms and conditions. For more information on the terms and conditions, please contact us.

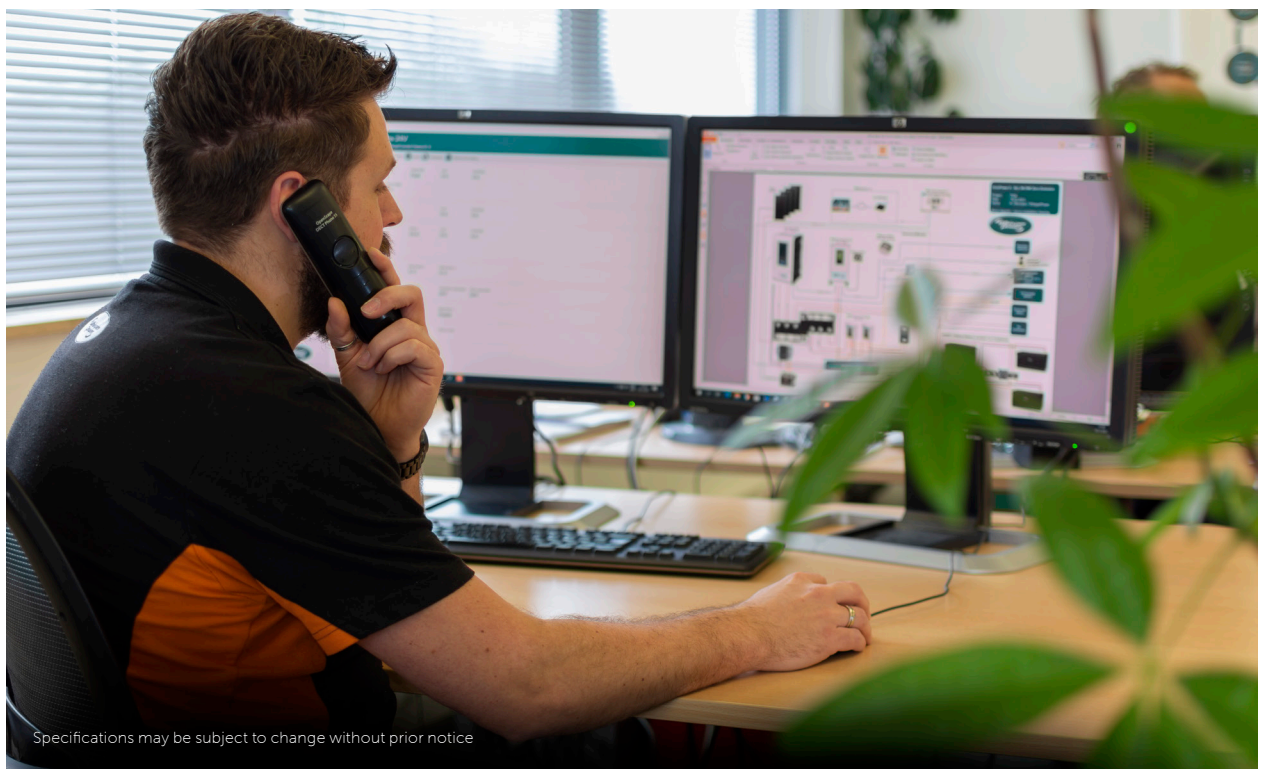

Specifications may be subject to change without prior notice

Service & Support

In case of malfunction or repair, our technical representatives from our global network will provide you with service and technical support for repairs or malfunctions. Where possible, support and service work will be carried out on-site. This applies worldwide.

Regular training: up-to-date expertise

Knowledge and expertise form the foundation for the best possible service. Every WhisperPower technical sales partner has up-to-date knowledge and the benefit of our global experience. Regular training courses ensure our specialists stay abreast with and well informed about all of our products, both in terms of systems and applications. You can, therefore, be certain that WhisperPower offers far more than a box with a device: we offer you our expertise as standard.

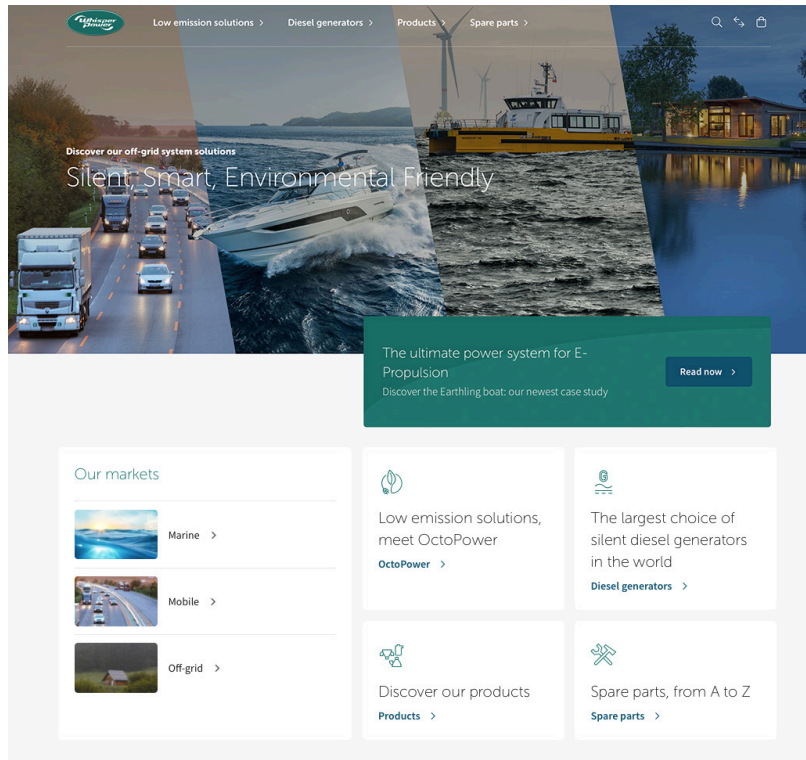

Minimal downtime during repairs

We have mobile service partners active in every conceivable region. To keep down time to a minimum, trouble shooting and repair work are carried out on-site. If needed, we will supply a replacement system to ensure continuous operation is maintained.

Up-to-date product specifications

Detailed specifications of the WhisperPower products can be found on our website and throughout this brochure and other printed product information. As we continuously strive to improve our products, specifications can be subject to change without prior notice.

The WhisperPower Warranty Plan

When purchasing our products and systems, you always have the certainty of a dedicated WhisperPower WarrantyPlan. This plan covers as standard the costs of repairs and/or replacement of defective parts when products are used in 'normal' circumstances. The conditions for the WhisperPower WarrantyPlan are specific to the product and the use thereof in your system. The standard warranty term for equipment is two years. With an authorised system installations maintenance contract, the warranty term can be extended to five years. For electronic equipment and components, the standard product warranty is 5 years.

With sales in over 50 countries we make sure our distributors, dealers and installers serve you well;

- Extended system advice
- Selection of the right parts
- Installation of the system or generator
- Commissioning after installation
- Maintenance training
- Repair in case of a defect
- Software updates, when needed
- All our efforts are aiming to reduce unnecessary downtime.

(English/ German/Spanish/French/Italian/Dutch)

Available documentation

WhisperPowerBook | Product and Components | All Markets



(English/ German/Spanish/French/Italian/Dutch)

Visit our website(s)

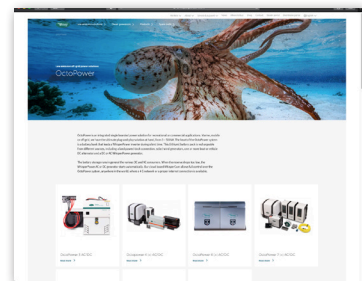
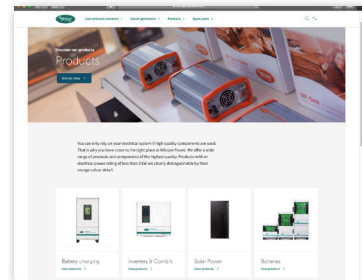
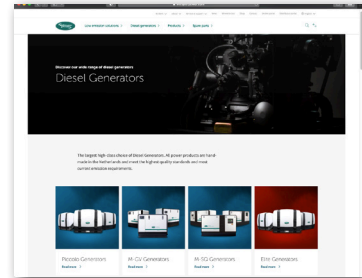
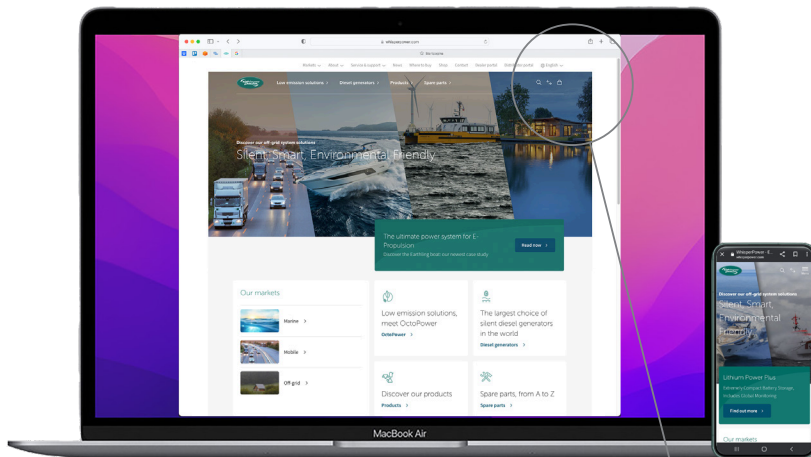

At WhisperPower we don't only think about the comfort in your vehicle, or vessel. We also want you to be able to enjoy browsing our website(s) in your own language.
Visit whisperpower.com and choose the language of your preference for an optimal experience of our online services.











Staff and dealers Corporate Wear

Polo shirts, caps, jackets and more can be purchased by our distributors. For more information send us an email to sales@whisperpower.com



Distribution in over 50 countries



-  International
-  Benelux
-  Germany
-  United Kingdom
-  Spain & Portugal
-  China
-  Pacific
-  Americas



Your dealer:

Enjoy Green Energy

sales@whisperpower.com | whisperpower.com